



# PRICE LIST 2020

# PARQUET INTELLIGENCE

OUR KNOWLEDGE.  
YOUR BENEFITS.



## A MATTER OF TRUST

Our family has been connected to the natural element, wood, for more than 180 years. After all, our home town Weiz is located in the middle of green Styria, the province in Austria with the largest abundance of forests. Just as our forests keep on growing, we also undergo continual development and growth. Dr. Nicola Weitzer and Mag. Alexandra Decker-Weitzer, who head the family enterprise, are the seventh generation to run the company. The responsibility for future generations is the driving force for decisions in favour of sustainability in economic, eco-logical, and social matters.

THIS IS PARQUET INTELLIGENCE:

**PERFECT SOLUTIONS**  
FOR ALL AREAS  
OF USE!

**Are you looking for a parquet floor that offers you practical benefits?**

**Our intelligent solutions:** Our maintenance-free, healthy, and sound reduction parquet's worldwide unique features as well as system-solution renovation with Weitzer Parkett are representative here of the numerous proofs of our innovative strength, which sets standards in matters of parquet, offering convenience, comfort and an enhanced sense of well being.

**"Made in Austria" is a special attribute of our products:**

- We perform each and every individual production step in Austria - from cutting the timber, to packaging of the parquet.
- Social responsibility is an integral part of our corporate policy, which is why we feel very strongly about ensuring that our personnel have jobs in Austria in the future as well.



# CONTENTS

## PRICES VALID FROM 01.01.2020

OVERVIEW OF ICONS . . . . .	04
OVERVIEW OF SURFACES . . . . .	05
OVERVIEW OF PRODUCTS AND COLOURS . . . . .	06-09
OUR COLOUR RANGES . . . . .	10-11
WEITZER PARKETT GRADINGS & HAPTICS . . . . .	12-13
WEITZER PARKETT APPEARANCES . . . . .	14-15
LAYING PATTERNS . . . . .	16-17
MAINTENANCE-FREE PARQUET . . . . .	18-19
HEALTHY PARQUET . . . . .	20-21
SOUND-REDUCTION PARQUET . . . . .	22-23
RENOVATING WITH WEITZER PARKETT . . . . .	24-25

MAINTENANCE-FREE PLANK COLLECTION . . . . .	26-27
HEALTHY PLANK COLLECTION . . . . .	28-29
PERFORMANCE PLANK COLLECTION . . . . .	30-31
HERRINGBONE COLLECTION . . . . .	32-33
COMFORT PLANK COLLECTION . . . . .	34

## iDESIGN PARQUET SPECIAL EDITIONS . . . . . 35

WP TWINART . . . . .	36-37
TWIST PARQUET . . . . .	38-39
OAK ALPINE SUN . . . . .	40-41

## PLANK APPEARANCE . . . . . 43

PRODUCTS . . . . .	44-49
OVERVIEW OF STOCK ITEMS . . . . .	50-51

IMPERIAL PLANK PRICES . . . . .	52-58
WP GRAND PLANK PRICES . . . . .	59-69
WP CHARISMA PLANK PRICES . . . . .	70-78
WP PERFORMANCE PLANK PRICES . . . . .	78-80
WP COMFORT PLANK PRICES . . . . .	82-84
WP QUADRA 1800 PRICES . . . . .	86-93

## WIDEBOARD APPEARANCE . . . . . 95

PRODUCTS . . . . .	96-98
OVERVIEW OF STOCK ITEMS . . . . .	99

WP 4140 PRICES . . . . .	100-106
WP 4100 PRICES . . . . .	107-113
WP CHARISMA 2-STRIP PRICES . . . . .	114-115

## BLOCK APPEARANCE . . . . . 117

PRODUCTS . . . . .	118-120
OVERVIEW OF STOCK ITEMS . . . . .	121-122

WP 475 PRICES . . . . .	123-126
WP 450 PRICES . . . . .	127-130
WP CHARISMA 3-STRIP PRICES . . . . .	131-134

## STRIP APPEARANCE . . . . . 135

PRODUCTS . . . . .	136
OVERVIEW OF STOCK ITEMS . . . . .	137
WP STRIP 45 PRICES . . . . .	138-139

## WOODEN STAIRS WP MULTI 141

WOODEN STAIRS WP MULTI . . . . .	142-146
HANDRAILS . . . . .	147
WP MULTI ACCESSORIES . . . . .	148

## PARQUET SKIRTINGS . . . . . 149

PRODUCTS . . . . .	150-151
PRICES . . . . .	152-156

## ACCESSORIES . . . . . 157

ADHESIVES . . . . .	160
MAINTENANCE & CARE PROSTRONG . . . . .	161
MAINTENANCE & CARE PROACTIVE+ . . . . .	162
MAINTENANCE & CARE PROVITAL FINISH . . . . .	163
UNDERLAY/BASE . . . . .	165
ACCESSORIES . . . . .	166

## GENERAL . . . . . 167

WOOD - AT ITS BEST . . . . .	168-169
ENVIRONMENTAL RESPONSIBILITY . . . . .	170-172
GENERAL TERMS AND CONDITIONS OF BUSINESS . . . . .	173-174



## PARQUET STRUCTURE



### 2-LAYER PARQUET

A spruce base layer, combined with a real hardwood top layer gives a low floor height construction, which is ideal for renovations



### 3-LAYER PARQUET

A spruce counterbalance base, combined with a spruce core and a real hardwood top layer gives the highest level of stability - even with floating installation

## CONNECTION SYSTEM



### TONGUE AND GROOVE

4-side tongue and groove connection



### DOUBLE-CLICK

Intelligent, patented double-click system with the greatest interlocking power on the market

## WEAR LAYER THICKNESS



### APPROX. 2,5 TO 5,0 mm

This refers to the thickness of the hardwood top layer

## INSTALLATION TECHNIQUES



### COMPLETE ADHESION

Products that are suitable for complete adhesion to subfloor



### FLOATING INSTALLATION

Products that are suitable for floating installation on recommended underlays



### FLOATING ADHESION

Suitable for the floating adhesion on the underlay WP Looseglue

## HYDROSTOP



### UNIQUE, ALL-ROUND JOINT-EDGE IMPREGNATION

The Hydrostop impregnation applied at the factory provides the ultimate protection against the ingress of moisture due to small spillages

## HERRINGBONE INSTALLATION



### LEFT AND RIGHT HAND BLOCKS

Allows for a wide variety of possible installation patterns

## WOODEN STAIRS WP MULTI



### DON'T FORGET:

there's a stair covering to match every parquet! No matter what wood species, format, colour and additional treatment you use

## SUITABLE FOR UNDERFLOOR HEATING\*

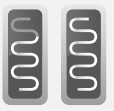
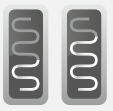

### LIMITED TO VERY GOOD

depending on the relevant layout (level of heating loop), suitable for underfloor heating

LIMITED SUITABLE IDEALLY

## HARDNESS GRADE OF WOOD SPECIES\*



### SOFT TO VERY HARD

The hardness of the wood is especially important in terms of pressure points - wear resistance is additionally increased by means of the surface finish

SOFT MEDIUM STRONG VERY STRONG

\* More about this, beginning on page 168



MAIN-  
TENANCE  
FREE  
**PARQUET**



SOUND-  
REDUCTION  
**PARQUET**

Pre-finished lacquered sealing, consisting of 7 matched eco friendly layers in a satin gloss optical appearance

**YOU SEE** a satin gloss appearance

**YOU FEEL** a uniform lacquered finish

**INTELLIGENT CHARACTERISTICS**

- Maintenance-free for residential living
- Meets Class C of ÖNORM C 2354 (the highest standard for anti-scratch and resistance against certain chemicals, etc.)



**PROSTRONG**

LACQUERED  
SURFACE  
FINISH



MAIN-  
TENANCE  
FREE  
**PARQUET**



SOUND-  
REDUCTION  
**PARQUET**

Combines the advantages of the ProStrong surface finish (maintenance-free) with the appearance of the natural Oiled finish Provital

**YOU SEE** - the natural surface

**YOU FEEL** the pores

**INTELLIGENT CHARACTERISTICS**

- Maintenance-free for residential living
- Meets Class C of ÖNORM C 2354 (the highest standard for anti-scratch and resistance against certain chemicals, etc.)



**PROACTIVE+**

THE NATURAL  
MATT SURFACE  
FINISH



HEALTHY  
**PARQUET**



SOUND-  
REDUCTION  
**PARQUET**

Oil from natural, plant-based raw materials and natural resins, sealing the open pores\*

**YOU SEE** a satiny matt appearance

**YOU FEEL** the wood structure up close

**INTELLIGENT CHARACTERISTICS**

- Regular maintenance refreshes the impregnation/protective layer. It is thus ideal for commercial applications.
- Especially breathable. Can be partially renovated.
- Surface oiled at the end of the workshop production execute.

\* It is essential that an additional finish be applied to the floor after installation if it is to be used in a public area.



**PROVITAL finish**

THE NATURAL  
OILED SURFACE  
FINISH



**IMPERIAL PLANK**

3-layer Parquet

Dimensions: 3500 x 350 x 18 mm

Dimensions: 3500 x 300 x 18 mm

0 cm 100 cm 200 cm 300 cm 350 cm

**WP GRAND PLANK**

3-layer Parquet

Dimensions: 2400 x 280 x 14 mm

Dimensions: 2400 x 240 x 14 mm

Dimensions: 2400 x 193 x 14 mm

0 cm 100 cm 200 cm 300 cm 350 cm

**WP CHARISMA PLANK**

3-layer Parquet | Dimensions: 2245 x 193 x 14 mm

0 cm 100 cm 200 cm 300 cm 350 cm

**WP PERFORMANCE PLANK**

2-layer Parquet | Dimensions: 1800 x 175 x 9,3 mm

0 cm 100 cm 200 cm 300 cm 350 cm

**WP COMFORT PLANK**

3-layer Parquet | Dimensions: 1800 x 175 x 11 mm

0 cm 100 cm 200 cm 300 cm 350 cm

**WP QUADRA 1800**

3-layer Parquet | Dimensions: 1800 x 175 x 14 mm

0 cm 100 cm 200 cm 300 cm 350 cm

COLOUR RANGE **LAVA**COLOUR RANGE **TERRA**
 **Oak Krokant** p. 52 | 55

 **Oak Krokant** p. 60 | 63 | 66

 **Fumed Oak Melange** p. 70

 **Fumed Oak** p. 70

 **Oak Cognac** p. 28 | 70

 **Oak Coffee** p. 70

 **Oak Havana** p. 70

 **Oak Krokant** p. 71

 **Oak Havana** p. 34 | 82

 **Fumed Oak** p. 86

 **Nut steamed** p. 86

 **Oak Krokant** p. 86

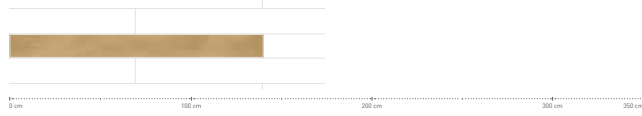
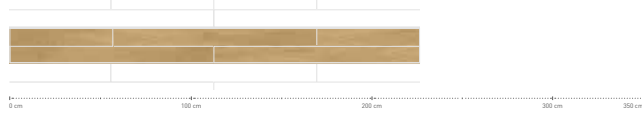
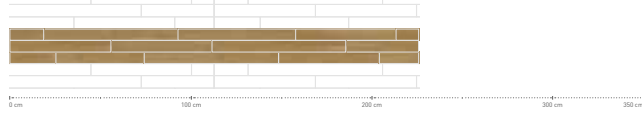

COLOUR RANGE <b>FIRE</b>	COLOUR RANGE <b>NATUR</b>	COLOUR RANGE <b>STONE</b>	COLOUR RANGE <b>SAND</b>
	<ul style="list-style-type: none"> <li> <b>Oak Mandel</b> p. 52   55</li> <li> <b>Oak</b> p. 52   55</li> <li> <b>Oak Pure</b> p. 52   55</li> </ul>	<ul style="list-style-type: none"> <li> <b>Oak Auster</b> p. 53   56</li> <li> <b>Oak Kaschmir</b> p. 53   56</li> <li> <b>Oak Ice</b> p. 53   56</li> <li> <b>Oak Savanne</b> p. 53   56</li> <li> <b>Oak Polar</b> p. 54   57</li> <li> <b>Oak Trüffelgrau</b> p. 54   57</li> <li> <b>Oak Taupe</b> p. 54   57</li> </ul>	
	<ul style="list-style-type: none"> <li> <b>Oak Mandel</b> p. 60   63   66</li> <li> <b>Oak</b> p. 60   63   66</li> <li> <b>Oak Pure</b> p. 60   61   63   64   66   67</li> </ul>	<ul style="list-style-type: none"> <li> <b>Oak Auster</b> p. 61   64   67</li> <li> <b>Oak Kaschmir</b> p. 61   64   67</li> <li> <b>Oak Ice</b> p. 61   64   67</li> <li> <b>Oak Savanne</b> p. 61   62   64   65   67   68</li> <li> <b>Oak Polar</b> p. 62   65   68</li> <li> <b>Oak Trüffelgrau</b> p. 62   65   68</li> <li> <b>Oak Taupe</b> p. 62   65   68</li> </ul>	
	<ul style="list-style-type: none"> <li> <b>Oak Mandel</b> p. 26   28   71   72</li> <li> <b>Oak</b> p. 26   28   72</li> <li> <b>Oak light</b> p. 72</li> <li> <b>Oak Pure</b> p. 29   73</li> </ul>	<ul style="list-style-type: none"> <li> <b>Oak Auster</b> p. 26   29   73   74</li> <li> <b>Oak Kaschmir</b> p. 27   29   74</li> <li> <b>Oak Ice</b> p. 27   74   75</li> <li> <b>Oak Savanne</b> p. 75</li> <li> <b>Oak Polar</b> p. 75   76</li> <li> <b>Oak Trüffelgrau</b> p. 29   76</li> <li> <b>Oak Colorado Diamond Ice</b> p. 77</li> <li> <b>Oak Taupe</b> p. 77</li> </ul>	<ul style="list-style-type: none"> <li> <b>Stone Pine Edelweiss</b> p. 77</li> <li> <b>Ash</b> p. 27   77</li> </ul>
	<ul style="list-style-type: none"> <li> <b>Oak</b> p. 30   80</li> </ul>	<ul style="list-style-type: none"> <li> <b>Oak Savanne</b> p. 31   80</li> </ul>	
	<ul style="list-style-type: none"> <li> <b>Oak</b> p. 34   82</li> <li> <b>Oak Pure</b> p. 34   82</li> </ul>	<ul style="list-style-type: none"> <li> <b>Oak Auster</b> p. 34   82</li> <li> <b>Oak Kaschmir</b> p. 34   82</li> <li> <b>Oak Savanne</b> p. 83</li> <li> <b>Ash Polar</b> p. 83</li> <li> <b>Oak Colorado Diamond Ice</b> p. 83</li> </ul>	
	<ul style="list-style-type: none"> <li> <b>Oak Mandel</b> p. 86   87</li> <li> <b>Oak</b> p. 87   88</li> <li> <b>Oak Pure</b> p. 88</li> </ul>	<ul style="list-style-type: none"> <li> <b>Oak Auster</b> p. 88   89</li> <li> <b>Oak Kaschmir</b> p. 89</li> <li> <b>Oak Ice</b> p. 90</li> <li> <b>Oak Savanne</b> p. 90</li> <li> <b>Oak Polar</b> p. 91</li> <li> <b>Oak Trüffelgrau</b> p. 91</li> <li> <b>Oak Taupe</b> p. 92</li> </ul>	

## WIDEBOARD-APPEARANCE



**WP 4140****2-layer Parquet** | Dimensions: 1400 x 140 x 11 mm**WP 4100****2-layer Parquet** | Dimensions: 1000 x 125 x 11 mm**WP CHARISMA 2-STRIP****3-layer Parquet** | Dimensions: 2245 x 193 x 14 mm**WP 475****2-layer Parquet** | Dimensions: 750 x 125 x 12,2 mm**WP 450****2-layer Parquet** | Dimensions: 500 x 65 x 11 mm**WP CHARISMA 3-STRIP****3-layer Parquet** | Dimensions: 2245 x 193 x 14 mm**WP STRIP 45****2-layer Parquet** | Dimensions: 360 x 108 x 11 mm



## STRIP-APPEARANCE



COLOUR RANGE **LAVA**

-  **Fumed Oak Melange** p. 100
-  **Fumed Oak** p. 100

COLOUR RANGE **TERRA**

-  **Oak Coffee** p. 100
-  **Oak Krokant** p. 100 | 101



-  **Fumed Oak Melange** p. 107
-  **Fumed Oak** p. 107

-  **Nut steamed** p. 107
-  **Oak Coffee** p. 107
-  **Oak Krokant** p. 108



-  **Fumed Oak Ice** p. 114

-  **Nut steamed** p. 114

-  **Fumed Oak** p. 126

-  **Nut steamed** p. 126
-  **Oak Coffee** p. 126























































-  **Fumed Oak** p. 130

-  **Nut steamed** p. 130
-  **Oak Havanna** p. 130

-  **Fumed Oak** p. 138

-  **Nut steamed** p. 138



COLOUR RANGE <b>FIRE</b>	COLOUR RANGE <b>NATUR</b>	COLOUR RANGE <b>STONE</b>	COLOUR RANGE <b>SAND</b>
	<ul style="list-style-type: none"> <li> <b>Oak Mandel</b> p. 101</li> <li> <b>Oak</b> p. 101</li> <li> <b>Oak Pure</b> p. 102</li> </ul>	<ul style="list-style-type: none"> <li> <b>Oak Auster</b> p. 102</li> <li> <b>Oak Kaschmir</b> p. 102   103</li> <li> <b>Oak Ice</b> p. 103</li> <li> <b>Oak Savanne</b> p. 103</li> <li> <b>Oak Polar</b> p. 104</li> <li> <b>Oak Trüffelgrau</b> p. 104</li> <li> <b>Oak Taupe</b> p. 104   105</li> </ul>	
<ul style="list-style-type: none"> <li> <b>Robinia steamed</b> p. 108</li> </ul>	<ul style="list-style-type: none"> <li> <b>Oak Mandel</b> p. 108</li> <li> <b>Oak</b> p. 109</li> <li> <b>Oak Pure</b> p. 109</li> </ul>	<ul style="list-style-type: none"> <li> <b>Oak Auster</b> p. 110</li> <li> <b>Oak Kaschmir</b> p. 110</li> <li> <b>Oak Ice</b> p. 110   111</li> <li> <b>Oak Savanne</b> p. 111</li> <li> <b>Oak Polar</b> p. 111</li> <li> <b>Oak Trüffelgrau</b> p. 112</li> <li> <b>Oak Colorado Diamond Ice</b> p. 112</li> <li> <b>Oak Taupe</b> p. 112</li> </ul>	
	<ul style="list-style-type: none"> <li> <b>Oak</b> p. 114</li> </ul>	<ul style="list-style-type: none"> <li> <b>Oak Kaschmir</b> p. 114</li> <li> <b>Ash Polar</b> p. 114</li> </ul>	
	<ul style="list-style-type: none"> <li> <b>Oak Mandel</b> S. 32   123   124   125</li> <li> <b>Oak</b> S. 32   123   124   125</li> <li> <b>Oak Pure</b> S. 32   123   124   125</li> </ul>	<ul style="list-style-type: none"> <li> <b>Oak Auster</b> S. 33   123   124   125</li> <li> <b>Oak Kaschmir</b> S. 33   123   124   125</li> <li> <b>Oak Colorado Diamond Ice</b> S. 33   123   124   125</li> </ul>	
<ul style="list-style-type: none"> <li> <b>Robinia steamed</b> p. 126</li> <li> <b>Beech steamed</b> p. 126</li> </ul>	<ul style="list-style-type: none"> <li> <b>Oak</b> p. 126   127</li> </ul>	<ul style="list-style-type: none"> <li> <b>Oak Auster</b> p. 127</li> <li> <b>Oak Kaschmir</b> p. 127</li> <li> <b>Oak Savanne</b> p. 127</li> </ul>	<ul style="list-style-type: none"> <li> <b>Ash Latte</b> p. 127</li> <li> <b>Canadian Maple</b> p. 128</li> <li> <b>Ash</b> p. 128</li> </ul>
<ul style="list-style-type: none"> <li> <b>Robinia steamed</b> p. 130</li> <li> <b>Cherry steamed</b> p. 130</li> <li> <b>Beech steamed</b> p. 130</li> </ul>	<ul style="list-style-type: none"> <li> <b>Oak</b> p. 131</li> <li> <b>Oak Pure</b> p. 131</li> </ul>	<ul style="list-style-type: none"> <li> <b>Oak Auster</b> p. 131</li> <li> <b>Oak Kaschmir</b> p. 131</li> <li> <b>Oak Savanne</b> p. 131</li> <li> <b>Ash Polar</b> p. 132</li> </ul>	<ul style="list-style-type: none"> <li> <b>Canadian Maple</b> p. 132</li> <li> <b>Ash</b> p. 132</li> </ul>
<ul style="list-style-type: none"> <li> <b>Robinia steamed</b> p. 138</li> </ul>	<ul style="list-style-type: none"> <li> <b>Oak</b> p. 138</li> </ul>	<ul style="list-style-type: none"> <li> <b>Oak Kaschmir</b> p. 138</li> </ul>	<ul style="list-style-type: none"> <li> <b>Ash</b> p. 138</li> </ul>







# MOTHER NATURE GIVES US HER COLOURS

OUR SOURCE OF  
INSPIRATION.



## LAVA

Colour Range LAVA:  
Strong and powerful colour tones. The dark and dusky nuances will produce mysterious and magical shadows and shade, creating an atmosphere of timeless beauty.



## TERRA

Colour Range TERRA:  
Earthy colour tones - the source of life. Captured in brown hues, these colours will ground your surroundings giving your room warmth and comfort.



## FIRE

Colour Range FIRE:  
Passionate colours from one end of the red spectrum to the other. These dynamic, bright colours give a feeling of wellbeing and vitality



## NATUR

Colour Range Nature:  
Refined colour tones. Subtle beautiful shades, neither light nor dark. Understated and restrained, giving a classical finish to your room.



## STONE

Our parquet colour range STONE :  
A colour range that is full of surprises with its multitude of shades. Varying from cool, light tones, through to the exciting darker versions which will give your rooms a modern and stylish appearance.



## SAND

Colour Range SAND:  
A glimpse of the seaside. Colour tones that remind you of long sandy beaches the outdoors, and the sound of the sea. These bright hues will bring a feeling of relaxation into your life.



# GRADINGS AND HAPTICS

AS VARIED AS LIFE.

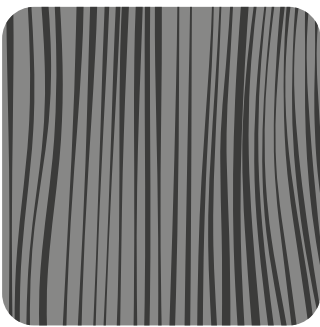

## EXQUISITE

The elegant and calm appearance given by grain and colour (with no light-coloured sapwood) satisfies the most exquisite taste.

**Characteristics:** pin knots, fine grain, no sapwood, rift grain

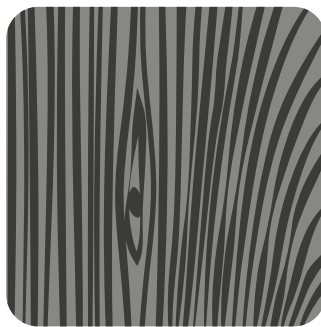

## CALM (NATURE AND SELECT)

This grading mixes a timeless grain combination, from simple to decorative.

**Characteristics:** small knots, natural colour variation, no sapwood



## LIVELY (ACCENT, ORIGINAL\*)

This grading has a high percentage of sound knots with an even colour variation without sapwood.

**Characteristics:** knots, natural grain variation no sapwood

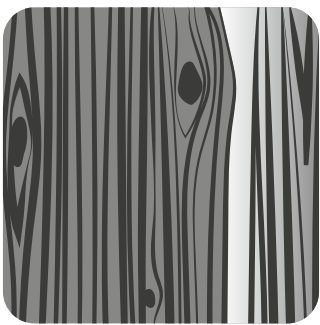

## LIVELY COLOURFUL

(NATURAL, ORIGINAL, SPECTRUM, STRUCTURE)

The lively colourful grading offers the whole variety of nature. The large proportion of sapwood produces a harmonious, colourful appearance.

**Characteristics:** knots, sapwood and natural grain



## RUSTIC

(ESSENCE, VIBRANT, ORIGINAL\*)

This grade demonstrates the natural growth characteristics of the oak tree.

**Characteristics:** no limitation on size of knots, open knots, head cracks and variations in colour are permitted, no sapwood



## RUSTIC COLOURFUL

(VIBRANT, RUSTIC, ORIGINAL)

The proportion of sapwood produces a colourful appearance with the full expressive power of the tree. Shows character and leaves the tree alive as a piece of living nature.

**Characteristics:** knots of unlimited size, smoothed-out knots and head cracks, sapwood with natural grain variation, distinct variation in colour and timber structure



### BEVELLED

accentuates the plank appearance  
adding depth and presence



### BRUSHED

emphasizes the natural structure  
of the wood grain



### DEEP BRUSHED

Emphasizes the wood structure  
intensely



### INTENSELY BRUSHED

hand-crafted features



### SCRAPED

soft, varied planing imparts a special look  
and feel



# WEITZER PARKETT APPEARANCES

FOR EVERY STYLE,  
WE OFFER THE RIGHT  
FORMAT.

## PLANK APPEARANCE

- Expressive wood effect which is close-to-nature and works well in large spaces
- Elegant, lively and timeless
- The characteristics of the wood are completely retained, ensuring every floor is unique
- Also available as Grand Plank, which performs a strong appearance with its length and three widths



## WIDEBOARD- APPEARANCE

- Generous format between plank and block appearance
- Expression of contemporary design
- Especially well-suited to large, commercial or residential areas
- Also fits stylishly into smaller rooms
- The classic herringbone and French herringbone laying patterns are also possible





## BLOCK APPEARANCE

- Timeless, classic format
- Harmonizes with any furniture style
- Offers the greatest freedom of choice of installation patterns, such as herringbone, plait, shifted dice and lamella
- Also perfect for combining with other products



## STRIP APPEARANCE

- Unique design from Weitzer Parkett
- Multi-faceted strip appearance in contemporary design
- Gives the room a lively look and a personal touch
- Extraordinarily effective, especially when installed on stairs (waterfall appearance)



## LAYING PATTERNS

## AT A GLANCE

## PLANK APPEARANCE

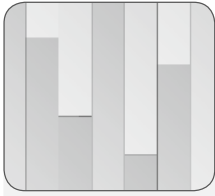

STRAIGHT

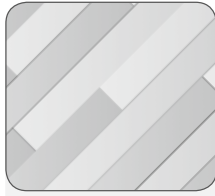

DIAGONAL

## WIDEBOARD APPEARANCE

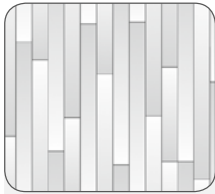

STRAIGHT

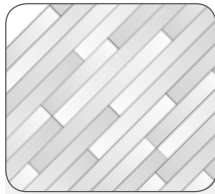

DIAGONAL



LADDER-TYPE\*

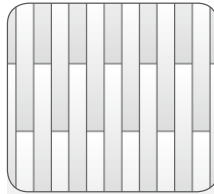

LAMELLA PATTERN \*\*

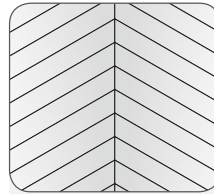
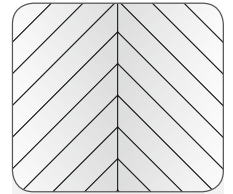
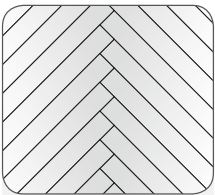
FRENCH  
HERRINGBONE (60°) \*\*FRENCH  
HERRINGBONE (45°) \*\*

HERRINGBONE \*\*

## BLOCK APPEARANCE

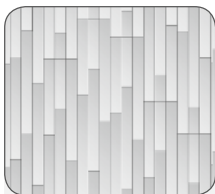
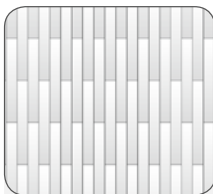
SHIPDECK  
STRAIGHTSHIPDECK  
DIAGONAL

LAMELLA PATTERN \*\*

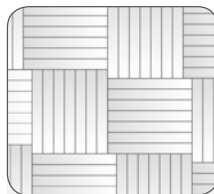
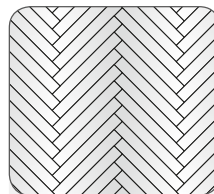
SHIFTED  
DICE \*\*

HERRINGBONE \*\*

TWIN-  
HERRINGBONE \*\*

TRIPLE PLAIT \*\*

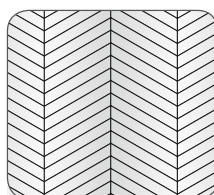
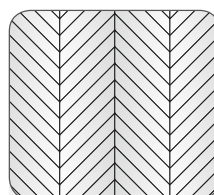

QUADRUPLE PLAIT \*\*

DIAGONAL  
LAMELLA \*\*FRENCH  
HERRINGBONE (60°) \*\*FRENCH  
HERRINGBONE (45°) \*\*

\* Pattern possible with WP 4140 and WP 4100

\*\* Pattern possible with WP 4140, WP 4100 and WP 450

Applies to French Herringbone: All items suitable, except bevelled products with the ProStrong and ProActive + surfaces.

## STRIP APPEARANCE

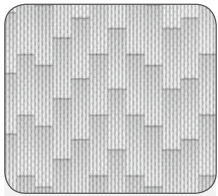
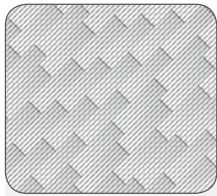
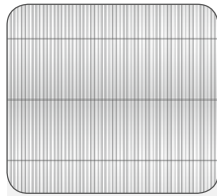
NATURAL LAMELLA  
STRAIGHTNATURAL DIAGONAL  
LAMELLA

PARALLEL



SHIFTED DICE

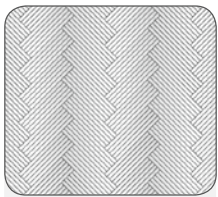

HERRINGBONE

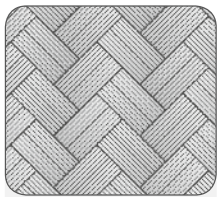
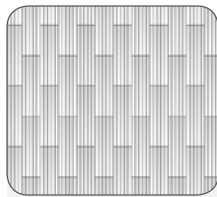
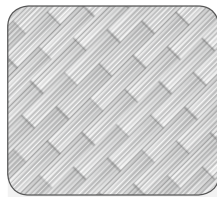
TWIN-  
HERRINGBONECONTINUOUS  
LAMELLA PATTERN  
STRAIGHTCONTINUOUS  
LAMELLA PATTERN  
DIAGONAL

## COMBINATIONS

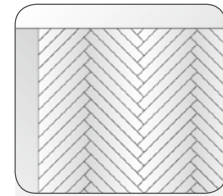
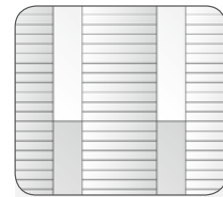
HERRINGBONE WITH  
BORDER DETAIL \*\*\*LADDER-TYPE  
COMBINATION \*\*\*

\*\*\* Combination: WP 4100 / WP 450

## EXAMPLE - HERRINGBONE (BLOCK APPEARANCE)



## A timeless classic

No matter if featured in popular house and home magazines or at interior design fairs: **we are breathing fresh life into herringbone floors.**

Achieve different impressive effects using French herringbone laid at 60° or 45°!

Herring-bone and French herringbone are possible in product groups WP 4140, WP 4100, and WP 450! See pages 96, 97, and 126 concerning this.

# MAINTENANCE-FREE PARQUET

UNIQUE WORLDWIDE: NO  
MAINTENANCE REQUIRED,  
SAVES YOU TIME AND MONEY.

I ADORE ACCURATE  
APPEARANCES.

REVOLUTIONARY  
TECHNOLOGY MEANS ONLY  
GENTLE CLEANING IS NEEDED.



SHOWS  
DURABILITY.

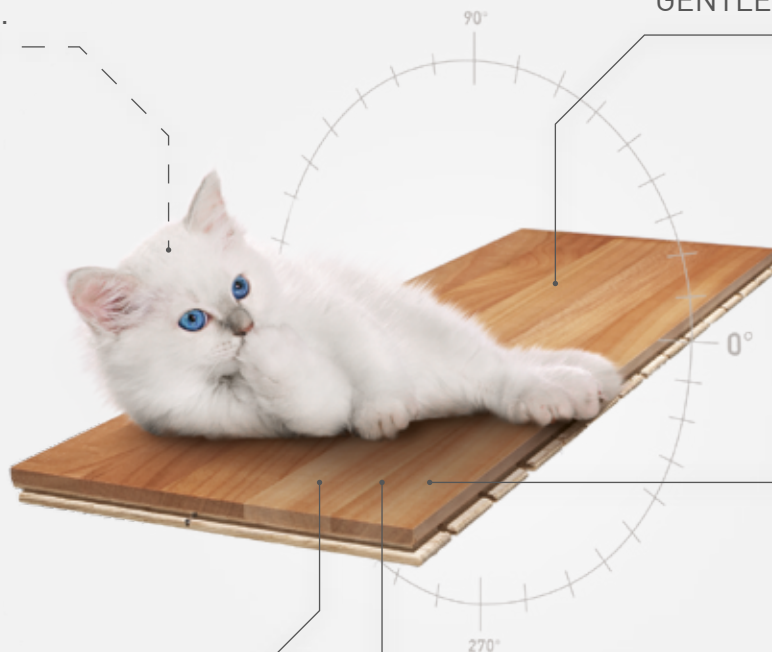

COMPLICATED AND  
TIME CONSUMING  
MAINTENANCE IS NO  
LONGER REQUIRED.

OUR SPECIAL PORE  
SEALING PROCESS.

THIS IS PARQUET INTELLIGENCE:

THE WORLD'S FIRST **MAINTENANCE-FREE PARQUET!**

**Are you looking for a parquet floor that offers you practical benefits?**

**Our Intelligent Solution:** The unique, special sealing that goes down to the pores, makes our parquet maintenance free. All it takes is a gentle clean saving time and money. Your floor remains beautiful without any maintenance.



## WHAT WE UNDERSTAND BY MAINTENANCE-FREE PARQUET

Weitzer Parkett are the first and only manufacturer of this type of parquet flooring. For residential use, the complicated and time consuming maintenance is no longer required. For ProStrong and ProActive+ surfaces, only a light cleaning is required.



YOU CAN ALWAYS IDENTIFY OUR MAINTENANCE-FREE PRODUCTS BY THE MAINTENANCE-FREE SYMBOL

### GUARANTEED BY:

- **7-LAYER UV CURING EXECUTE:**

The unique sealing technology of the ProStrong surface, protects the parquet against scratches, abrasion and heavy duty / wear and tear. Multi-layer sealing is also available in a natural matt effect as the ProActive+ surface.

- **ONE OF THE LARGEST HARDWOOD-KILN-DRYING FACILITIES IN EUROPE:**

Decades of experience in the drying of wood help guarantee greater inherent stability and fitting-accuracy. This helps reduce the appearance of gaps, because the timber has been kiln dried to the level it is expected to achieve in service. ie. EMC - Equilibrium Moisture Content.

- **SHOWS DURABILITY.**

Our maintenance-free parquet is extremely resistant to scratches and chemicals.



## RADIANTLY BEAUTIFUL - DAY IN AND DAY OUT



- **SPECIAL WEITZER PARKETT CLEANING PRODUCTS:**

Cleaning products that have been specifically developed for Maintenance-free parquet, guarantees long lasting, clean, hygienic and beautiful parquet floors. A small amount of water and the "Clever Cleaner" or, alternatively Cleaning Soap is all that is required. No additional care and maintenance is necessary. Weitzer Parkett cleaning products are ecologically tested and are completely harmless to humans and environmentally friendly

Refer to the Parkett Primer for detailed instructions

- **ALL-ROUND PROTECTION WITH JOINT-EDGE IMPREGNATION**

- WP Charisma has the finish applied ex-factory
- Reduces water penetration at the header and longitudinal edges
- Increases the resistance of your parquet to liquids on a permanent basis

# HEALTHY PARQUET

FOR A PERFECT  
INDOOR CLIMATE.

I LOVE ITS  
NATURE.

CREATE HEALTHY  
SURROUNDINGS WITH  
THE AAAA-EFFECT.



100% PURE AND  
TOTALLY NATURAL.

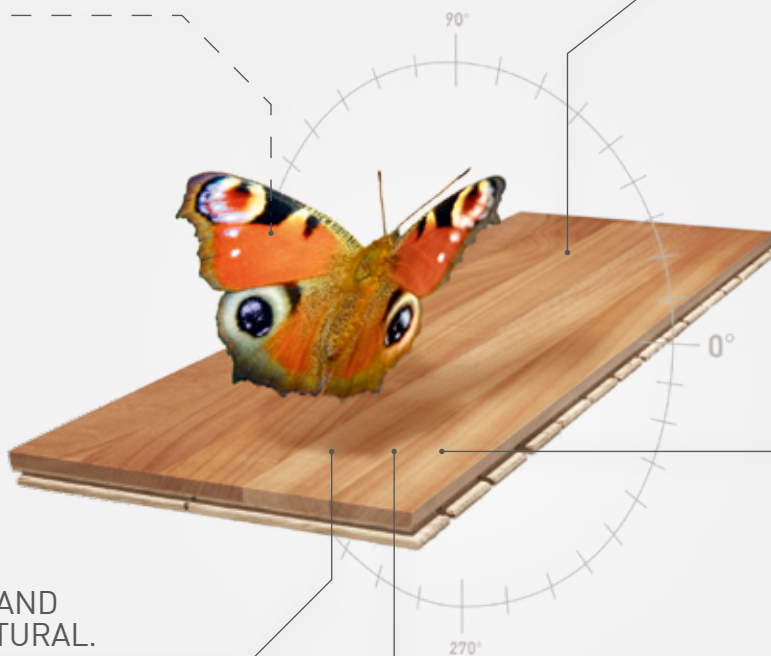

PROMOTES  
WELL-BEING.

PERCEIVED HIGHER  
FLOOR TEMPERATURE  
BY UP TO 2.2 °C.

THIS IS PARQUET INTELLIGENCE:

## THE FIRST **HEALTHY PARQUET** WITH AAAA-EFFECT!

**Are you looking for a parquet floor that offers you healthy surroundings?**

**Our Intelligent Solution:** our healthy parquet with its allergy-free, antibacterial, antistatic and alive qualities, creates a hygienic, healthy atmosphere of well-being. Contrary to carpets, dust and dirt cannot get a permanent foothold on the smooth surfaces and mites have no habitat. With its special surfaces, you feel the wood structure very close: intensely brushed or scraped.



## WHAT WE UNDERSTAND BY HEALTHY PARQUET

This type of floor covering has a significant influence on individuals. Weitzer Parkett have created Healthy Parquet specifically to provide and promote a healthy climate and wellbeing.



HEALTHY

YOU CAN  
ALWAYS  
IDENTIFY  
OUR HEALTHY  
PRODUCTS BY  
THE HEALTHY  
SYMBOL

### THE UNIQUE ADVANTAGES:

#### - 100% PURE - NATURAL OILS AND WAXES FROM RENEWABLE RESOURCES

The surface of the healthy parquet is treated only with natural oils and waxes that penetrate deep into the pores and provide the parquet with strong protection. This extremely breathable surface creates a sense of well being and healthy living that helps restrict / reduce / remove allergens from the environment of the potential allergy sufferer. When it comes to appearance, our healthy parquet boasts a natural timber structure that really stands out thanks to the oiled surface.

#### - THE NATURAL MATERIAL WOOD

Wood brings comfort and warmth into the room. The latest studies of an independent German test institute prove: Increase in surface temperature for parquet compared to

- laminate by up to 0.8°C
- tiles by up to 2.2°C

This helps save heating costs!

#### - ROOM CLIMATE REGULATION

Wood in a room promotes regulation of the humidity and the optimum conditions are 50% humidity and 20°C room temperature. The more wood within a room, the better the climate can be controlled, health problems triggered by too dry or humid air are minimized.

#### - THE AAAA -EFFECT

Allergy-sufferer friendly | **Antibacterial** | **Antistatic** | **Alive**

The perfect surfaces, By it's allergy-free antibacterial, antistatic and alive qualities, Weitzer Parkett creates a hygienic, healthy atmosphere of well-being. Contrary to carpets, dust and dirt cannot get a permanent foothold on the smooth surfaces and mites have no habitat.

### PARQUET CARE!



#### - PARQUET FOR A LIFE TIME

When it comes to wooden floors, a distinction is made between cleaning and care. Ongoing cleaning ensures a clean surface day in and day out. Parquet care protects the wood and gives protection. Regular care ensures that the surface retains its original finish.

Refer to the instruction to parquet brochure for more information.

# SOUND-REDUCTION PARQUET

COMPACTNESS IN IT'S  
QUIETEST, MOST  
BEAUTIFUL FORM.

DRASTIC  
NOISE-  
REDUCTION!

I LOVE THE PEACE  
AND QUIET.

FORMS PERFECT  
BOND TO THE  
SUBSTRATE.

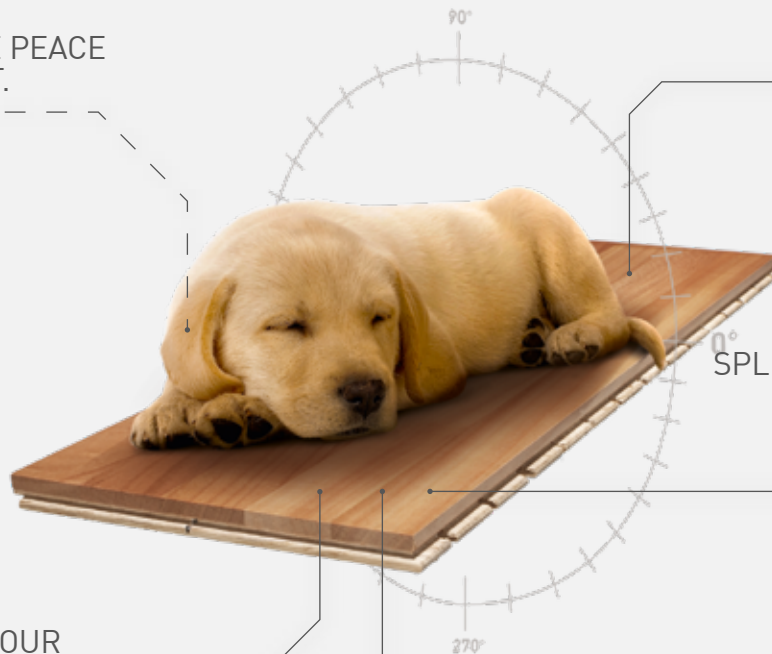

SPLENDID ROOM ACOUS-  
TICS VIA  
PLEASANT  
FREQUENCY RANGE.

ENHANCES YOUR  
WELL-BEING.

ADDITIONAL NOISE REDUCTION IN  
CONJUNCTION WITH WP LOOSEGLUE

THIS IS PARQUET INTELLIGENCE:

**SOUND-REDUCTION PARQUET -**  
ENSURES PERFECT ROOM ACOUSTICS



Do you long for peace and quiet?

**Our Intelligent Solution:** The firm bond between parquet and substrate engenders compactness. According to independent German testing, our bonded whisper parquet is up to three times quieter than laminate. Added to this is the beneficial frequency range of the raw material, wood — not for nothing are concert halls and instruments often made of it.

## WHAT WE UNDERSTAND BY SOUND-REDUCTION PARQUET

Room acoustics play a vital role in personal well-being. Weitzer Parkett specializes in this field and the Sound-reduction parquet helps to create an atmosphere of relaxation.

### – THE NATURAL MATERIAL WOOD

In contrast to other floor coverings, parquet guarantees a comfortable frequency range. There are good reasons why concert halls and musical instruments are manufactured from wood.

### – PERMANENT BOND

Complete surface bonding by professionals, provides perfect contact with the underlay, thereby minimising distribution of ambient sound.

### – THE PROVITAL-SURFACE

Our Sound-reduction parquet achieves an outstanding reduction of ambience noise due the printive surface texture of the timbers used.

### – WP LOOSEGLUE AND SOUND-REDUCTION PARQUET: A DREAMTEAM!

Thanks to the outstanding noise-reduction abilities of the WP Looseglue underlay one can achieve a reduction of subsonic noise by 18dB and a significant reduction of ambient noise at the same time. The result is the splendidly deep, compact sound of your footsteps. You combine the advantages of the two installation techniques — floating installation and the adhesion of the parquet — killing two birds with one stone; it's a completely dust-free renovation and an improvement in room acoustics. The result is the splendidly deep, compact sound of your footsteps.

## OUR SOUND-REDUCTION SOLUTIONS:

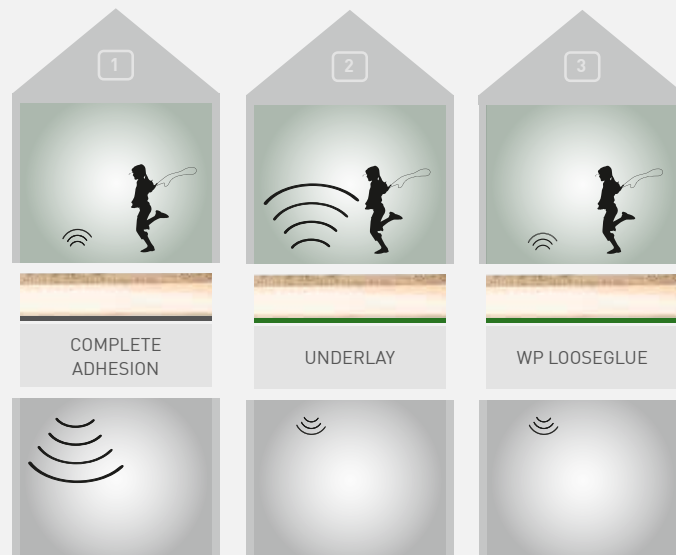
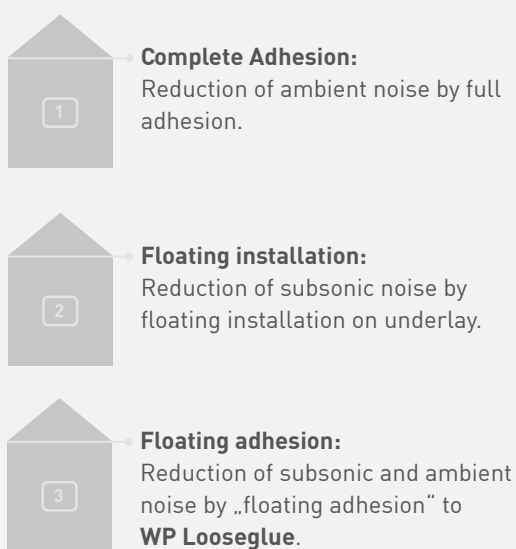

# RENOVATING WITH WEITZER PARKETT

SO FAST.  
SO DUST-FREE.  
SO QUIET.

FAST,  
DUST-FREE,  
QUIET RENOVATION

OLD FLOOR  
COVERING REMAINS  
IN THE ROOM



SIMPLE REMOVAL  
POSSIBLE

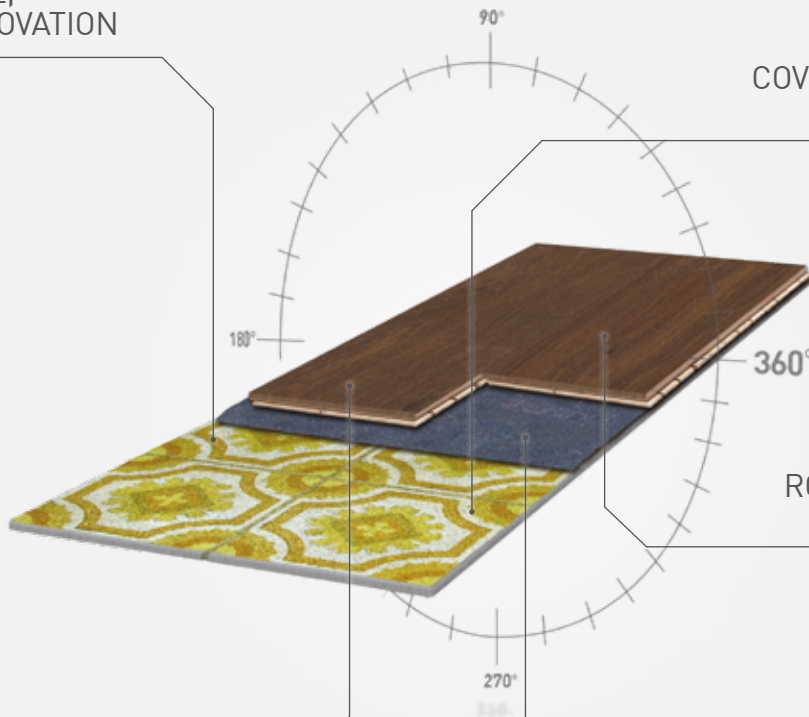

ROOM IS IMMEDIATELY  
WALKABLE



SIGNIFICANT NOISE  
REDUCTION

THIS IS PARKETT INTELLIGENCE:

RENOVATION HAS NEVER BEEN **SO FAST,**  
**SO DUST-FREE AND QUIET.**

**Would you like your floor to be renovated quickly, without dust, and as quietly as possible?**

**Our intelligent solution:** With the system solution from Weitzer Parkett, you renovate your floor within a few hours. The old floor covering can remain in the room. The new parquet floor is immediately walkable. No dust and no noise in order to tear out the old floor. The system simultaneously combines all of the advantages of professional adhesion and floating installation! You achieve the greatest noise reduction and hear only the splendidly deep, compact sound of your footsteps.

## WHAT WE MEAN BY RENOVATION

One generally ponders the renovation of a floor covering for a long time. One fears the effort and costs. However with Weitzer Parkett, that more often means renovation WITHOUT dust, WITHOUT noise, and WITHOUT boring tasks.

**Weitzer Parkett has developed an overall solution that enables dust-free renovation. One achieves perfect room acoustics as well.**



ADHESION  
FLOATING

YOU  
RECOGNIZE  
PRODUCTS  
THAT CAN BE  
INSTALLED  
WITH WP  
LOOSEGLUE  
BY THIS IN-  
STALLATION  
SYMBOL.

### THE UNIQUE BENEFITS:

#### – FAST, DUST-FREE, QUIET RENOVATION

With the renovation solution from Weitzer Parkett, you work quickly, without dust, and quietly! The simplest installation technique guarantees a customer- AND craftsmanship-friendly solution.

#### – THE OLD FLOOR COVERING STAYS IN THE ROOM

Your new parquet is installed over the old floor covering. The unique WP Looseglue matting finds space between them. The difference to traditional underlay mats for floating installation consists in adhesion to the parquet so that even most 2- and 3- layer products can be installed. A level difference can be avoided in most cases in combination with parquet having a less thickness. The parquet is immediately walkable again after installation.

#### – FAST, SIMPLE INSTALLATION

The most important adjustments to the renovation work, for example to door linings and skewed masonry, are now quite simple. Adjust until the element sits perfectly then pull off the WP Looseglue's cover film and done! Entirely without adhesive! Tongue-and-groove products are especially well suited for this.

#### – THE ROOM IS IMMEDIATELY WALKABLE

Movable furniture can also stay in the room — you push it to one side of the room and install on the other. Then repeat the same procedure with the other half of the room. The room can be traversed again immediately thanks to the system solution with intelligent installation technique.

#### – PERFECT ROOM ACOUSTICS

Thanks to the outstanding noise-reduction abilities of the WP Looseglue underlay one can achieve a reduction of subsonic noise by 18dB and a significant reduction of ambient noise at the same time. The result is the splendidly deep, compact sound of your footsteps. You combine the advantages of the two installation techniques — floating installation and the adhesion of the parquet — killing two birds with one stone; it's a completely dust-free renovation and an improvement in room acoustics.

#### – SIMPLE REMOVAL POSSIBLE

WP Looseglue is also ideal for preserving the subfloor regardless of whether it's a floor worthy of historical preservation or a simple lettable area that is destined to be returned to its original condition after use. Easy removal also offers an uncomplicated renovation solution if the wish for a new parquet floor exists years later.

.....

## THE MAINTENANCE-FREE PLANK COLLECTION

## MAINTENANCE-FREE PLANK FAN STAND

TOTAL SIZE: H 2200 x W 730 x D 1160 mm

## Sample panels included:

**WP CHARISMA PLANK** (Format: 900 x 386 mm)

Oak Mandel | rustic (essence) | bevelled, brushed

Oak | calm (select) | bevelled, brushed

Oak | rustic (essence) | bevelled, brushed

Oak Auster | rustic (essence) | bevelled, brushed

Oak Kaschmir | lively (accent) | bevelled





Ash | lively colourful (natural) | bevelled, brushed

## Back wall:

Oak Ice | lively (accent) | bevelled

Item No. 62585  
**€ 211,15** excl. VAT

## OVERVIEW OF PRODUCTS

COLOUR RANGE NATURE	
	<p><b>WP CHARISMA PLANK</b> 3-layer   Dimensions: 2245 x 193 x 14 mm   1 Package = 2,60 m<sup>2</sup> <span style="float: right;">Item No. 51886</span></p> <hr/> <p><b>OAK MANDEL</b> rustic (essence)   bevelled, brushed   ProActive+ <span style="float: right;">EURO/m<sup>2</sup> <b>68,19</b></span></p>
	<p><b>WP CHARISMA PLANK</b> 3-layer   Dimensions: 2245 x 193 x 14 mm   1 Package = 2,60 m<sup>2</sup> <span style="float: right;">Item No. 20930</span></p> <hr/> <p><b>OAK</b> calm (select)   bevelled, brushed   ProActive+ <span style="float: right;">EURO/m<sup>2</sup> <b>90,74</b></span></p>
	<p><b>WP CHARISMA PLANK</b> 3-layer   Dimensions: 2245 x 193 x 14 mm   1 Package = 2,60 m<sup>2</sup> <span style="float: right;">Item No. 20931</span></p> <hr/> <p><b>OAK</b> rustic (essence)   bevelled, brushed   ProActive+ <span style="float: right;">EURO/m<sup>2</sup> <b>64,07</b></span></p>
	<p><b>WP CHARISMA PLANK</b> 3-layer   Dimensions: 2245 x 193 x 14 mm   1 Package = 2,60 m<sup>2</sup> <span style="float: right;">Item No. 43804</span></p> <hr/> <p><b>OAK AUSTER</b> rustic (essence)   bevelled, brushed   ProActive+ <span style="float: right;">EURO/m<sup>2</sup> <b>68,19</b></span></p>



## PARQUET-CHARACTERISTICS



### BEVELLED

accentuates the plank appearance adding depth and presence



### BRUSHED

emphasizes the natural structure of the wood grain



### NATURAL

vibrant structure, the wood's accentuated naturalness



#### COLOUR RANGE STONE



### WP CHARISMA PLANK

3-layer | Dimensions: 2245 x 193 x 14 mm | 1 Package = 2,60 m<sup>2</sup>

Item No. 20932



### OAK KASCHMIR

lively (accent) | bevelled | ProActive+

EURO/m<sup>2</sup>

**76,22**

#### COLOUR RANGE STONE



### WP CHARISMA PLANK

3-layer | Dimensions: 2245 x 193 x 14 mm | 1 Package = 2,60 m<sup>2</sup>

Item No. 20933



### OAK ICE

lively (accent) | bevelled | ProActive+

EURO/m<sup>2</sup>

**79,83**

#### COLOUR RANGE SAND



### WP CHARISMA PLANK

3-layer | Dimensions: 2245 x 193 x 14 mm | 1 Package = 2,60 m<sup>2</sup>

Item No. 20935



### ASH

lively colourful (natural) | bevelled, brushed | ProActive+

EURO/m<sup>2</sup>

**65,20**





## THE HEALTHY PLANK COLLECTION

## HEALTHY PLANK FAN STAND

TOTAL SIZE: H 2200 x W 730 x D 1160 mm

## Sample panels included:

**WP CHARISMA PLANK** (Format: 900 x 386 mm)

- Oak Cognac | rustic (essence) | bevelled, scraped
- Oak Mandel | rustic (essence) | bevelled, brushed
- Oak | rustic (essence) | bevelled, intensely brushed
- Oak | rustic (essence) | bevelled, scraped
- Oak Pure | lively (accent) | bevelled, brushed
- Oak Auster | rustic (essence) | bevelled, scraped
- Oak Kaschmir | rustic (essence) | bevelled, brushed

## Back wall:

**WP CHARISMA PLANK**

Oak Trüffelgrau | calm (select) | bevelled



Item No. 62581

€ 252,35 excl. VAT



## OVERVIEW OF PRODUCTS

## COLOUR RANGE TERRA

**WP CHARISMA PLANK**3-layer | Dimensions: 2245 x 193 x 14 mm | 1 Package = 2,60 m<sup>2</sup>

Item No. 49438

**OAK COGNAC**

rustic (essence) | bevelled, scraped | ProVital finish

EURO/m<sup>2</sup>**87,24**

## COLOUR RANGE NATURE

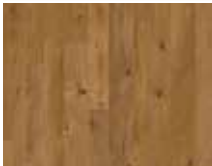
**WP CHARISMA PLANK**3-layer | Dimensions: 2245 x 193 x 14 mm | 1 Package = 2,60 m<sup>2</sup>

Item No. 29174

**OAK MANDEL**

rustic (essence) | bevelled, brushed | ProVital finish

EURO/m<sup>2</sup>**71,79**

## COLOUR RANGE NATURE

**WP CHARISMA PLANK**3-layer | Dimensions: 2245 x 193 x 14 mm | 1 Package = 2,60 m<sup>2</sup>

Item No. 50059

**OAK**

rustic (essence) | bevelled, intensely brushed | ProVital finish

EURO/m<sup>2</sup>**78,49**

## COLOUR RANGE NATURE

**WP CHARISMA PLANK**3-layer | Dimensions: 2245 x 193 x 14 mm | 1 Package = 2,60 m<sup>2</sup>

Item No. 49436

**OAK**

rustic (essence) | bevelled, scraped | ProVital finish

EURO/m<sup>2</sup>**81,58**

## PARQUET-CHARACTERISTICS



### BEVELLED

accentuates the plank appearance  
adding depth and presence



### BRUSHED

emphasizes the natural  
structure of the wood grain



### INTENSELY BRUSHED

hand-crafted features



### SCRAPED

soft, varied planing imparts a  
special look and feel

#### COLOUR RANGE NATURE



#### WP CHARISMA PLANK

3-layer | Dimensions: 2245 x 193 x 14 mm | 1 Package = 2,60 m<sup>2</sup>

Item No. **52063**



#### OAK PURE

lively (accent) | bevelled, brushed | ProVital finish

EURO/m<sup>2</sup>

**82,40**

#### COLOUR RANGE STONE

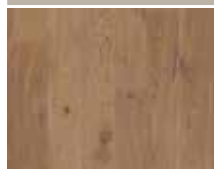

#### WP CHARISMA PLANK

3-layer | Dimensions: 2245 x 193 x 14 mm | 1 Package = 2,60 m<sup>2</sup>

Item No. **49437**



#### OAK AUSTER

rustic (essence) | bevelled, scraped | ProVital finish

EURO/m<sup>2</sup>

**87,24**

#### COLOUR RANGE STONE



#### WP CHARISMA PLANK

3-layer | Dimensions: 2245 x 193 x 14 mm | 1 Package = 2,60 m<sup>2</sup>

Item No. **29172**



#### OAK KASCHMIR

rustic (essence) | bevelled, brushed | ProVital finish

EURO/m<sup>2</sup>

**71,79**

#### COLOUR RANGE STONE



#### WP CHARISMA PLANK

3-layer | Dimensions: 2245 x 193 x 14 mm | 1 Package = 2,60 m<sup>2</sup>

Item No. **63841**



#### OAK TRÜFFELGRAU

calm (select) | bevelled | ProVital finish

EURO/m<sup>2</sup>

**100,01**



## PERFORMANCE-PLANK COLLECTION

### PERFORMANCE-PLANK SAMPLE BOARD

TOTAL SIZE: H 870 x W 355 x D 30 mm

#### Sample panels included:

##### WP PERFORMANCE PLANK (Format: 193 x 150 mm)

- Oak | calm (select) | bevelled, brushed | PA+
- Oak | lively (accent) | bevelled, brushed | PA+
- Oak | lively (accent) | bevelled, deep brushed | PVf
- Oak | lively (accent) | bevelled, scraped | PVf
- Oak Savanne | lively colourful (original) | bevelled, brushed | PA+
- Oak Savanne | lively colourful (original) | bevelled, deep brushed | PVf

Incl. cross  
section sample



PROACTIVE+



MAINTENANCE  
FREE



PROVITAL



HEALTHY

Item No. 56608

€ 32,96 excl. VAT

## OVERVIEW OF PRODUCTS

#### COLOUR RANGE NATURE



##### WP PERFORMANCE PLANK

2-layer | Dimensions: 1800 x 175 x 9,3 mm mm | 1 Package = 2,52 m<sup>2</sup>

Item No. 56703

##### OAK

calm (select) | bevelled, brushed | ProActive+

EURO/m<sup>2</sup>

67,57

#### COLOUR RANGE NATURE



##### WP PERFORMANCE PLANK

2-layer | Dimensions: 1800 x 175 x 9,3 mm mm | 1 Package = 2,52 m<sup>2</sup>

Item No. 60221

##### OAK

lively (accent) | bevelled, brushed | ProActive+

EURO/m<sup>2</sup>

55,93

#### COLOUR RANGE NATURE



##### WP PERFORMANCE PLANK

2-layer | Dimensions: 1800 x 175 x 9,3 mm mm | 1 Package = 2,52 m<sup>2</sup>

Item No. 60222

##### OAK

lively (accent) | bevelled, deep brushed | ProVital finish

EURO/m<sup>2</sup>

60,05

#### COLOUR RANGE NATURE

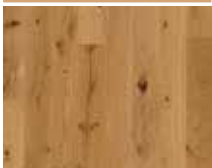

##### WP PERFORMANCE PLANK

2-layer | Dimensions: 1800 x 175 x 9,3 mm mm | 1 Package = 2,52 m<sup>2</sup>

Item No. 60223

##### OAK

lively (accent) | bevelled, scraped | ProVital finish

EURO/m<sup>2</sup>

73,44



## PARQUET-CHARACTERISTICS

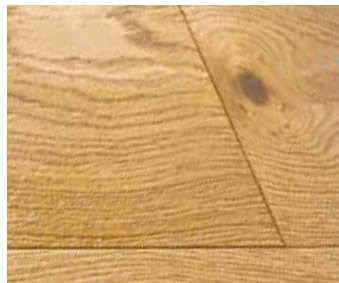

### BEVELLED

accentuates the plank appearance adding depth and presence



### BRUSHED

emphasizes the natural structure of the wood grain



### DEEP BRUSHED

Emphasizes the wood structure intensely



### SCRAPED

soft, varied planing imparts a special look and feel

### COLOUR RANGE STONE



#### WP PERFORMANCE PLANK

2-layer | Dimensions: 1800 x 175 x 9,3 mm mm | 1 Package = 2,52 m<sup>2</sup>

Item No. **56705**



#### OAK SAVANNE

lively colourful (original) | bevelled, brushed | ProActive+

EURO/m<sup>2</sup>

**56,34**

### COLOUR RANGE STONE



#### WP PERFORMANCE PLANK

2-layer | Dimensions: 1800 x 175 x 9,3 mm mm | 1 Package = 2,52 m<sup>2</sup>

Item No. **56706**



#### OAK SAVANNE

lively colourful (original) | bevelled, deep brushed | ProVital finish

EURO/m<sup>2</sup>

**62,01**



## HERRINGBONE COLLECTION

## HERRINGBONE FAN STAND

TOTAL SIZE: H 2200 x W 950 x D 1150 mm

**Sample panels included:** (Sample format: 1.000 x 800 mm)

Oak Mandel | lively colourful (spectrum) | bevelled, brushed | HB 90° | PA+  
 Oak Colorado Diamond Ice | lively colourful (spectrum) | bevelled, brushed | HB 90° | PA+  
 Oak Pure | lively (accent) | bevelled, brushed | HB 90° | PA+  
 Oak | lively (accent) | bevelled, brushed | HB 90° | PA+  
 Oak Auster | lively colourful (spectrum) | bevelled, brushed | HB 90° | PA+  
 Oak | calm (select) | bevelled, brushed | FHB 45° | PVf  
 Oak Kaschmir | lively (accent) | bevelled, brushed | FHB 60° | PVf

**Back wall:**

Oak Kaschmir | lively (accent)  
 bevelled, brushed | HB 90° | PA+



Item No. 63632

€ 465,00 excl. VAT



FISCHGRÄT

## OVERVIEW OF PRODUCTS

## COLOR RANGE NATUR

**WP 475**2-layer | Dimensions: 750 x 125 x 12,2 mm | 1 Package = 1,87 m<sup>2</sup>

Item No. 63659

**OAK MANDEL**

lively colourful (spectrum) | bevelled, brushed | ProActive+

EURO/m<sup>2</sup>**54,80**

## COLOR RANGE STONE

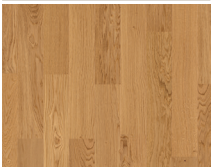
**WP 475**2-layer | Dimensions: 750 x 125 x 12,2 mm | 1 Package = 1,87 m<sup>2</sup>

Item No. 63655

**OAK**

calm (select) | bevelled, brushed | ProActive+

EURO/m<sup>2</sup>**58,00**

## COLOR RANGE NATUR

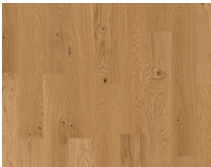
**WP 475**2-layer | Dimensions: 750 x 125 x 12,2 mm | 1 Package = 1,87 m<sup>2</sup>

Item No. 63657

**OAK**

lively (accent) | bevelled, brushed | ProActive+

EURO/m<sup>2</sup>**54,40**

## COLOR RANGE NATUR

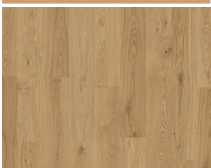
**WP 475**2-layer | Dimensions: 750 x 125 x 12,2 mm | 1 Package = 1,87 m<sup>2</sup>

Item No. 63662

**OAK PURE**

lively (accent) | bevelled, brushed | ProActive+

EURO/m<sup>2</sup>**58,40**

## PARQUET-CHARACTERISTICS



### BEVELLED

accentuates the block appearance  
adding depth and presence



### BRUSHED

emphasizes the natural  
structure of the wood grain

#### COLOR RANGE **STONE**



#### WP 475

2-layer | Dimensions: 750 x 125 x 12,2 mm | 1 Package = 1,87 m<sup>2</sup>

Item No. **63660**

### OAK AUSTER

lively colourful (spectrum) | bevelled, brushed | ProActive+

EURO/m<sup>2</sup>

**54,80**

#### COLOR RANGE **STONE**



#### WP 475

2-layer | Dimensions: 750 x 125 x 12,2 mm | 1 Package = 1,87 m<sup>2</sup>

Item No. **63658**

### OAK KASCHMIR

lively (accent) | bevelled, brushed | ProActive+

EURO/m<sup>2</sup>

**58,40**

#### COLOR RANGE **STONE**

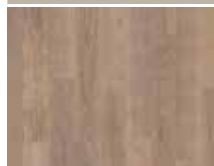

#### WP 475

2-layer | Dimensions: 750 x 125 x 12,2 mm | 1 Package = 1,87 m<sup>2</sup>

Item No. **63661**

### OAK COLORADO DIAMOND ICE

lively colourful (spectrum) | bevelled, brushed | ProActive+

EURO/m<sup>2</sup>

**61,80**





## THE COMFORT PLANK COLLECTION

## COMFORT PLANK FAN STAND

TOTAL SIZE: H 2200 x W 730 x D 776 mm

## Sample panels included:

## WP COMFORT PLANK (Format: 900 x 386 mm)

Oak Havana | rustic colourful (original) | bevelled, brushed  
 Oak | rustic (original\*) | bevelled, brushed  
 Oak Pure | rustic colourful (original) | bevelled, brushed  
 Oak Auster | rustic colourful (original) | bevelled, brushed  
 Oak Kaschmir | rustic colourful (original) | bevelled, brushed

## Back wall:

Oak Kaschmir | rustic colourful (original) | bevelled, brushed



Item No. 62590

€ 180,25 excl. VAT



## OVERVIEW OF PRODUCTS

COLOUR RANGE	WP COMFORT PLANK	Item No.	Price
TERRA	<b>WP COMFORT PLANK</b> 3-layer   Dimensions: 1800 x 175 x 11 mm   1 Package = 2,52 m <sup>2</sup> <b>OAK HAVANA</b> rustic colourful (original)   bevelled, brushed   ProActive+	48383	53,97
NATURE	<b>WP COMFORT PLANK</b> 3-layer   Dimensions: 1800 x 175 x 11 mm   1 Package = 2,52 m <sup>2</sup> <b>OAK</b> rustic (original*)   bevelled, brushed   ProActive+	48375	52,74
NATURE	<b>WP COMFORT PLANK</b> 3-layer   Dimensions: 1800 x 175 x 11 mm   1 Package = 2,52 m <sup>2</sup> <b>OAK PURE</b> rustic colourful (original)   bevelled, brushed   ProActive+	62192	53,97
STONE	<b>WP COMFORT PLANK</b> 3-layer   Dimensions: 1800 x 175 x 11 mm   1 Package = 2,52 m <sup>2</sup> <b>OAK AUSTER</b> rustic colourful (original)   bevelled, brushed   ProActive+	48377	53,97
STONE	<b>WP COMFORT PLANK</b> 3-layer   Dimensions: 1800 x 175 x 11 mm   1 Package = 2,52 m <sup>2</sup> <b>OAK KASCHMIR</b> rustic colourful (original)   bevelled, brushed   ProActive+	48381	53,97

\*no sapwood



**Stock item delivery time:** promptly ex works (from 200 m<sup>2</sup> on request) | **iDesign Parkett delivery time (from 20 m<sup>2</sup> per item):** three to max. four weeks ex works (A flat LP surcharge of 400 EUR is billed under 20 m<sup>2</sup>). All deliveries are based on the General Terms and Conditions of Business of Weitzer Parkett. All rights reserved for changes, composition and printing errors.

# iDESIGN PARQUET<sup>®</sup> SPECIAL EDITION

CONFIGURED ACCORDING  
TO YOUR TASTE BY  
WEITZER PARKETT



TWIST PARQUET | OAK ICE | RUSTIC (ESSENCE) | BEVELLED, STONEWASHED

WEITZERART: **TWINART**THE PRECIOUS ARTWORK  
OF TREES.

## TECHNICAL DATA:

- Imperial Plank | Oak & Fumed Oak
- Tongue and groove joint on four sides **(01)**
- The plank appearance is emphasized thanks to bevel of the longitudinal and header joints **(02)**
- Spruce supporting material with vertically arranged growth rings **(03)**
- Suitable for underfloor heating **(04)**
- We recommend complete adhesion to subfloor

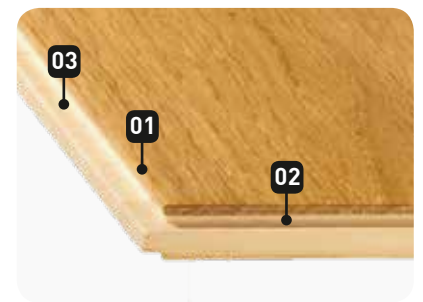

## DIMENSIONS:

2245 x 350 x 16,6 mm  
Overall thickness 16,6 mm with  
approx. 3 mm wear layer

0 cm 100 cm 200 cm 300 cm 350 cm

	<b>OAK</b>	ITEM NO.	EUR/m <sup>2</sup>
 PROVITAL finish	bevelled, deep brushed	iDESIGN PARQUET® SPECIAL EDITIONS	59917 <b>182,10</b>

Delivery times on request!

	<b>FUMED OAK</b>	ITEM NO.	EUR/m <sup>2</sup>
 PROVITAL finish	bevelled	iDESIGN PARQUET® SPECIAL EDITIONS	59916 -

Prices and delivery times on request!





PLANK APPEARANCE | 3-LAYER PARQUET



PLANK APPEARANCE | WP TWINART | FUMED OAK | BEVELLED



# TWIST PARQUET

YOUR PATTERN. MY PATTERN.  
INSTALL ME ANY WAY YOU WANT.

THE NEW PANEL APPEARANCE WITH MUCH MORE ROOM FOR CREATIVITY!

Twist parquet finally gives the room the individuality it deserves!

Weitzer Parkett combines the most important trends from haptics, colour and size in a unique item.

NEW!  
SOFTLINE

## TECHNICAL DATA:

- One longitudinal tongue —3-sided groove plus false tongue for the front side **(01)**
- Spruce supporting material with vertically arranged growth rings **(02)**
- With bevel **(03)** or trendy Soft Line **(04)** on request<sup>d</sup>

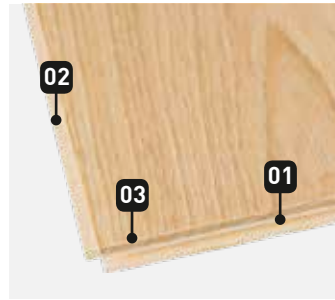

## 4 FORMATS

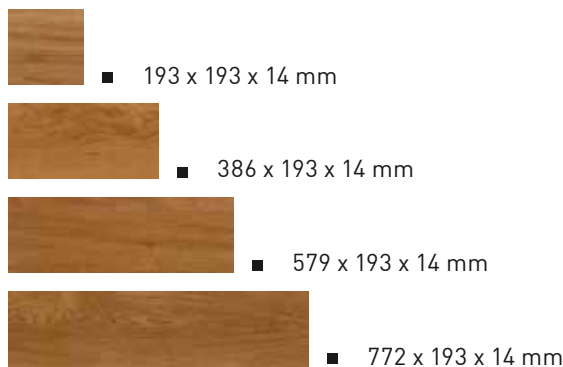

Total thickness for all four formats is 14 mm with about 3.6 mm top layer.

0 cm 100 cm

## 2 PRODUCT LINES

- OAK ICE | RUSTIC (ESSENCE) BEVELLED, STONEWASHED  
powerful white tones combined with a distinct brushing
- OAK | CALM (SELECT) | SOFTLINE  
a soft, rounded bevel enhances the formats

## DIMENSIONS: WP TWIST MIX

UNIT	PACKAGE	PALLET	ASSORTMENT PER PACKAGE: 4x: 193 x 193 x 14 mm   3x: 386 x 193 x 14 mm 2x: 579 x 193 x 14 mm   2x: 772 x 193 x 14 mm
CONTENTS	11 boards = 0,89 m <sup>2</sup>	72 packages = 64,08 m <sup>2</sup>	
DIMENSIONS	0,77 x 0,19 x 0,08 m	1,20 x 0,80 x 1,16 m	
WEIGHT	approx. 6,60 kg	approx. 475,20 kg	



**Delivery time (from 20 m<sup>2</sup>):** three to max. four weeks ex works (A flat LP surcharge of 400 EUR is billed under 20 m<sup>2</sup>.) The natural product wood has a long procurement lead time. As a result of high demand regarding particular species or grades the delivery time can be longer. All deliveries are based on the General Terms and Conditions of Business of Weitzer Parkett. All rights reserved for changes, composition and printing errors.

PANEL APPEARANCE | 3-LAYER PARQUET





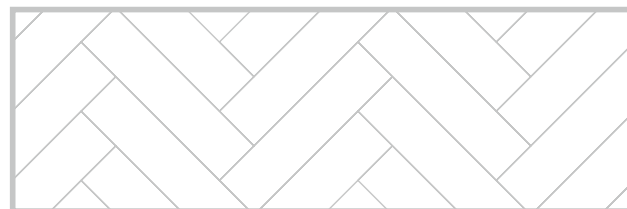
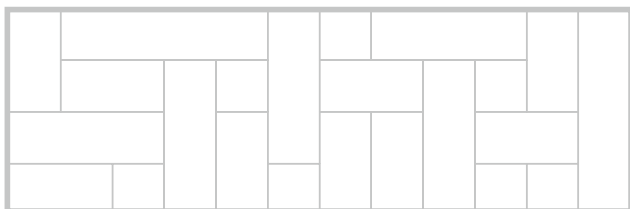

POSSIBLE LAYING PATTERNS—THE CHOICES ARE:

- **WP Twist MIX:** all four formats invite you to design and play - entirely individual and creative patterns emerge
- **WP Twist 772** > Completely en vogue - contemporary and generously interpreted:
- **WP Twist 579** > the traditional herringbone pattern in our exciting panel-appearance format.



- MIX pattern: an example of innumerable installation possibilities
- Herringbone pattern

					ITEM NO.	EUR/m <sup>2</sup>	
	<b>OAK ICE</b>						
WP Twist <b>MIX</b>		PROVITAL finish	rustic (essence)	bevelled, stonewashed	iDESIGN PARQUET® SPECIAL EDITIONS	50339	<b>104,75</b>
WP Twist <b>772</b>		PROVITAL finish	rustic (essence)	bevelled, stonewashed	iDESIGN PARQUET® SPECIAL EDITIONS	50379	<b>104,75</b>
WP Twist <b>579</b>		PROVITAL finish	rustic (essence)	bevelled, stonewashed	iDESIGN PARQUET® SPECIAL EDITIONS	50382	<b>104,75</b>

					ITEM NO.	EUR/m <sup>2</sup>	
	<b>OAK</b>						
WP Twist <b>MIX</b>		PROVITAL finish	calm (select)	sofline, deep brushed	iDESIGN PARQUET® SPECIAL EDITIONS	50378	<b>124,53</b>
WP Twist <b>772</b>		PROVITAL finish	calm (select)	sofline, deep brushed	iDESIGN PARQUET® SPECIAL EDITIONS	50381	<b>124,53</b>
WP Twist <b>579</b>		PROVITAL finish	calm (select)	sofline, deep brushed	iDESIGN PARQUET® SPECIAL EDITIONS	50383	<b>124,53</b>

**DIMENSIONS: WP TWIST 772 (772 x 193 x 14 mm)**

UNIT	PACKAGE	PALLET
CONTENTS	6 boards = 0,89 m <sup>2</sup>	72 packages = 64,08 m <sup>2</sup>
DIMENSIONS	0,77 x 0,19 x 0,08 m	1,20 x 0,80 x 1,16 m
WEIGHT	approx. 7,10 kg	approx. 511,20 kg

**DIMENSIONS: WP TWIST 579 (579 x 193 x 14 mm)**

UNIT	PACKAGE	PALLET
CONTENTS	6 boards = 0,67 m <sup>2</sup>	96 packages = 64,32 m <sup>2</sup>
DIMENSIONS	0,58 x 0,19 x 0,08 m	1,20 x 0,80 x 1,16 m
WEIGHT	approx. 5,20 kg	approx. 499,20 kg

# OAK ALPINE SUN

MY COLOUR IS LIKE  
THE GENTLE TOUCH OF THE SUN.

## TECHNICAL DATA:

- WP Charisma Plank | Oak Alpine sun
- Intelligent patented double-click system with the greatest interlocking power on the market. **(01)**
- Patented press-stud principle for simultaneous locking of the longitudinal and header joints in one movement **(02)**:
  - Fast and simple one-man assembly and disassembly
  - Can be completely adhered to the subfloor\*
- Header joint edge locking mechanism made from solid hardwood only - completely free from plastic components and plasticizers **(03)**
- Spruce supporting material with vertically arranged growth rings **(04)**

\* Ideally suited to underfloor heating, as it can be completely adhered to the subfloor

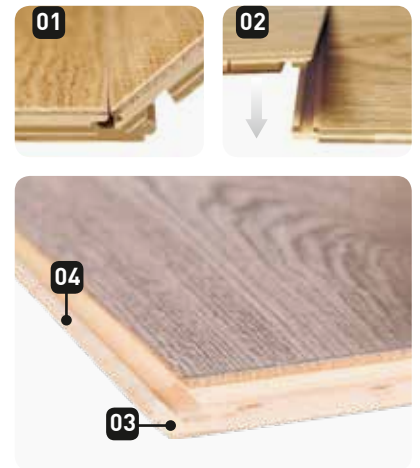

DIMENSIONS:  
2245 x 193 x 14 mm  
Overall thickness 14 mm with  
approx. 3,6 mm wear layer

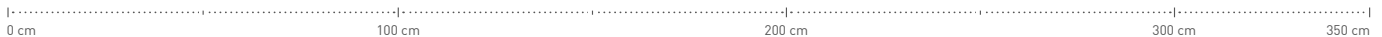

OAK ALPINE SUN		ITEM NO.	EUR/m <sup>2</sup>
PROVITAL finish	rustic (essence) bevelled, brushed	53553	91,36

## PACKING UNITS

UNIT	PACKAGE	PALLET
CONTENTS	6 boards = 2,60 m <sup>2</sup>	35 packages = 91,00 m <sup>2</sup>
DIMENSIONS	2,28 x 0,215 x 0,085 m	2,28 x 1,10 x 0,71 m
WEIGHT	approx. 19,80 kg	approx. 693 kg



**Delivery time (from 20 m<sup>2</sup>):** three to max. four weeks ex works (A flat LP surcharge of 400 EUR is billed under 20 m<sup>2</sup>.) The natural product wood has a long procurement lead time. As a result of high demand regarding particular species or grades the delivery time can be longer. All deliveries are based on the General Terms and Conditions of Business of Weitzer Parkett. All rights reserved for changes, composition and printing errors.

PLANK APPEARANCE | 3-LAYER PARQUET



PLANK APPEARANCE | OAK ALPINE SUN | RUSTIC (ESSENCE) | BEVELLED, BRUSHED







# PLANK APPEARANCE

## NATURE'S FINEST.

TRUE LUXURY:  
ONLY AROUND 17% OF THE TRUNK  
OF A TREE CAN BE USED TO  
ACHIEVE THE PLANK APPEARANCE!  
THAT MAKES EVERY PIECE A UNIQUE  
AND VALUABLE ITEM.



## IMPERIAL PLANK

## 3-LAYER PARQUET



- In two exclusive formats that demonstrate true splendour
- The plank appearance is emphasized thanks to bevelling of the longitudinal and header joints **(01)**
- Tongue and groove joint on four sides **(02)**
- Spruce supporting material with vertically arranged growth rings **(03)**
- Suitable for underfloor heating
- The Imperial plank has to be fully adhered



**Installing a fidbox® (climate measuring device) is strongly recommended.** This enables specialist advice to be sought including indoor climate optimization even after the parquet has been installed. This preserves the value and beauty of the floor and ensures a long life of the same.

## DIMENSIONS:

3500 x 350 x 18 mm | Overall thickness 18 mm with approx. 5 mm wear layer

WIDTH  
**350**

3500 x 300 x 18 mm | Overall thickness 18 mm with approx. 5 mm wear layer

WIDTH  
**300**

0 cm 100 cm 200 cm 300 cm 350 cm

**DIMENSIONS: 3500 x 350 x 18 mm**

UNIT	PACKAGE	PALLET
CONTENTS	2 boards = 2,45 m <sup>2</sup>	45 packages = 100,25 m <sup>2</sup>
DIMENSIONS	3,51 x 0,36 x 0,04 m	3,51 x 1,08 x 0,713 m
WEIGHT	approx. 21,8 kg	approx. 981 kg

**DIMENSIONS: 3500 x 300 x 18 mm**

UNIT	PACKAGE	PALLET
CONTENTS	2 boards = 2,10 m <sup>2</sup>	45 packages = 94,5 m <sup>2</sup>
DIMENSIONS	3,51 x 0,31 x 0,04 m	3,51 x 0,93 x 0,713 m
WEIGHT	approx. 18,7 kg	approx. 841,5 kg

EDGE PROFILE FOR STEPS: Fixed length: 3,50 m; profile 40, 40 style, 58 style and block style | Profile block style: riser is delivered loose.  
FOR ALL DIMENSIONS



The natural product wood has a long procurement lead time. As a result of high demand regarding particular species or grades the delivery time can be longer.  
All consignments underlie the sales-, payment terms and delivery conditions of Weitzer Parkett. Subject to change without prior notice.

## WP GRAND PLANK

### 3-LAYER PARQUET



- The plank appearance is emphasized thanks to bevelling of the longitudinal and header joints **(01)**
- Tongue and groove joints on four sides. Can be completely adhered to the subfloor. Also suitable for floating installation in optimal room climates **(02)**
- Spruce supporting material with vertically arranged growth rings **(03)**
- Ideally suited to underfloor heating, as it can be completely adhered to the subfloor

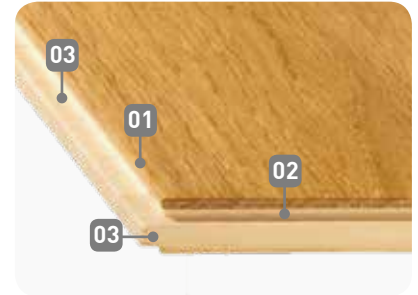

**Installing a fidbox® (climate measuring device) is strongly recommended.** This enables specialist advice to be sought including indoor climate optimization even after the parquet has been installed. This preserves the value and beauty of the floor and ensures a long life of the same.

#### DIMENSIONS:

2400 x 280 x 14 mm   Overall thickness 14 mm with approx. 3,6 mm wear layer	<b>WIDTH 280</b>
2400 x 240 x 14 mm   Overall thickness 14 mm with approx. 3,6 mm wear layer	<b>WIDTH 240</b>
2400 x 193 x 14 mm   Overall thickness 14 mm with approx. 3,6 mm wear layer	<b>WIDTH 193</b>

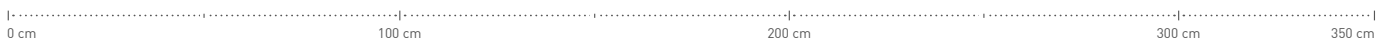

#### DIMENSIONS: 2400 x 280 x 14 mm

UNIT	PACKAGE	PALLET
CONTENTS	6 boards = 4,03 m <sup>2</sup>	24 packages = 96,77 m <sup>2</sup>
DIMENSIONS	2,41 x 0,29 x 0,08 m	2,41 x 1,17 x 0,612 m
WEIGHT	approx. 26,62 kg	approx. 649 kg

#### DIMENSIONS: 2400 x 240 x 14 mm

UNIT	PACKAGE	PALLET
CONTENTS	6 boards = 3,46 m <sup>2</sup>	24 packages = 82,94 m <sup>2</sup>
DIMENSIONS	2,41 x 0,25 x 0,08 m	2,41 x 1,01 x 0,612 m
WEIGHT	approx. 25,98 kg	approx. 633,7 kg

#### DIMENSIONS: 2400 x 193 x 14 mm

UNIT	PACKAGE	PALLET
CONTENTS	6 boards = 2,78 m <sup>2</sup>	30 packages = 83,38 m <sup>2</sup>
DIMENSIONS	2,41 x 0,20 x 0,08 m	2,41 x 1,03 x 0,612 m
WEIGHT	approx. 22,75 kg	approx. 692,5 kg

EDGE PROFILE FOR STEPS: Fixed length: 2,40 m; profile 40, 40 style, 58 style and block style | Profile block style: riser is delivered loose.  
FOR ALL DIMENSIONS



## WP CHARISMA PLANK

## 3-LAYER PARQUET



- Intelligent patented double-click system with the greatest interlocking power on the market. **(01)**
- Patented press-stud principle for simultaneous locking of the longitudinal and header joints in one movement **(02)**:
  - Fast and simple one-man assembly and disassembly
  - Can be completely adhered to the subfloor\*
- Header joint edge locking mechanism made from solid hardwood only - completely free from plastic components and plasticizers **(03)**
- Spruce supporting material with vertically arranged growth rings **(04)**
- HydroStop:
  - Unique all-round joint-edge impregnation
  - Provides the ultimate protection against the ingress of moisture due to small spillages
- Ideally suited to underfloor heating, as it can be completely adhered to the subfloor
- **NOW NEW:** The WP rotatable plank allows a simple modification of the laying direction



## DIMENSIONS:

2245 x 193 x 14 mm  
Overall thickness 14 mm with  
approx. 3,6 mm wear layer

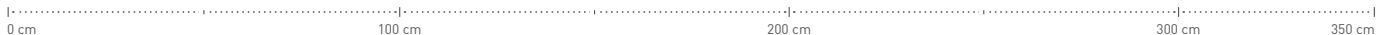

## PACKING UNITS

UNIT	PACKAGE	PALLET
CONTENTS	6 boards = 2,60 m <sup>2</sup>	35 packages = 91,00 m <sup>2</sup>
DIMENSIONS	2,28 x 0,215 x 0,085 m	2,28 x 1,10 x 0,71 m
WEIGHT	approx. 19,80 kg	approx. 693 kg
EDGE PROFILE FOR STEPS	Fixed length: 2,245 m; profile 40, 40 style, 58 style and block style. Block style: riser is delivered loose.	



## WP PERFORMANCE PLANK

### 2-LAYER PARQUET



- Low construction height : 9,3 mm
- For smooth transitions between rooms and different flooring materials
- Perfectly suited for renovation due to the low structural height
- The plank appearance is emphasized thanks to bevel of the longitudinal and header joints **(01)**
- Tongue and groove joint on four sides, optimally suited for complete surface bonding **(02)**
- Supporting material made from moisture resistant HDF **(03)**
- Ideally suited to underfloor heating



**DIMENSIONS:**  
1800 x 175 x 9,3 mm  
Overall thickness 9,3 mm with approx. 2,5 mm wear layer



### PACKING UNITS

UNIT	PACKAGE	PALLET
CONTENTS	8 boards = 2,52 m <sup>2</sup>	36 packages = 90,72 m <sup>2</sup>
DIMENSIONS	1,820 x 0,190 x 0,074 m	1,822 x 1,182 x 0,456 m
WEIGHT	approx. 20 kg	approx. 730 kg
EDGE PROFILE FOR STEPS	Fixed length: 1,80 m; profile 40, 40 style, 58 style and block style; Block style: riser is delivered loose.	



## WP COMFORT PLANK

## 3-LAYER PARQUET

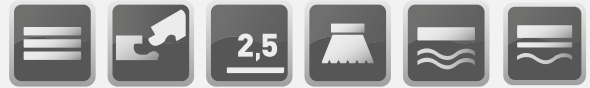

- Intelligent patented double-click system with the greatest interlocking power on the market. **(01)**
- Patented press-stud principle for simultaneous locking of the longitudinal and header joints in one movement **(02)**:
  - Fast and simple one-man assembly and disassembly
  - Can be completely adhered to the subfloor
- Header joint edge locking mechanism made from spruce wood only - completely free from plastic components and plasticizers **(03)**
- Spruce supporting material with vertically arranged growth rings **(04)**
- **NOW NEW:** The WP rotatable plank allows a simple modification of the laying direction



## DIMENSIONS:

1800 x 175 x 11 mm  
Overall thickness 11 mm with  
approx. 2,5 mm wear layer

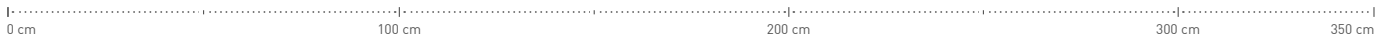

## PACKING UNITS

UNIT	PACKAGE	PALLET
CONTENTS	8 boards = 2,52 m <sup>2</sup>	42 packages = 105,84 m <sup>2</sup>
DIMENSIONS	1,8 x 0,175 x 0,011 m	1,82 x 1,2 x 0,74 m
WEIGHT	approx. 14,85 kg	approx. 623,7 kg
EDGE PROFILE FOR STEPS	Fixed length: 1,80 m; profile 40, 40 style, 58 style and block style. Block style: riser is delivered loose.	



## WP QUADRA 1800

### 3-LAYER PARQUET



- The plank appearance is emphasized thanks to bevelling of the longitudinal and header joints **(01)**
- Tongue and groove joints on four sides. Can be completely adhered to the subfloor. Also suitable for floating installation in optimal room climates **(02)**
- Spruce supporting material with vertically arranged growth rings **(03)**
- Suitable for underfloor heating; optimal with full-surface adhesion

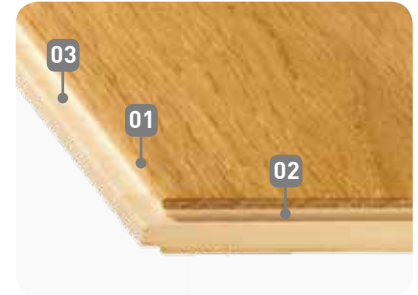

#### DIMENSIONS WP QUADRA 1800:

1800 x 175 x 14 mm

Overall thickness 14 mm with approx. 3,6 mm wear layer

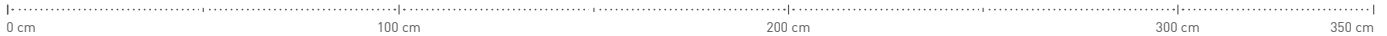

























#### PACKING UNITS | WP QUADRA 1800

UNIT	PACKAGE	PALLET
CONTENTS	6 boards = 1,89 m <sup>2</sup>	60 packages = 113,40 m <sup>2</sup>
DIMENSIONS	1,81 x 0,19 x 0,09 m	1,85 x 1,14 x 0,95 m
WEIGHT	approx. 12,35 kg	approx. 807 kg
EDGE PROFILE FOR STEPS	Fixed length: 1,80 m; profile 40, 40 style, 58 style and block style. Block style: riser is delivered loose.	

## COLOUR RANGE OVERVIEW















## STOCK ITEM

 <p>COLOR RANGE <b>LAVA</b> <b>FUMED OAK</b> lively (original*) ▪ WP Charisma Plank, WP Quadra</p>	 <p>COLOR RANGE <b>TERRA</b> <b>OAK COGNAC</b> rustic (essence) ▪ WP Charisma Plank</p>	 <p>COLOR RANGE <b>TERRA</b> <b>NUT STEAMED</b> lively colourful (original*) ▪ WP Quadra</p>	 <p>COLOR RANGE <b>TERRA</b> <b>OAK COFFEE</b> lively (original*) ▪ WP Charisma Plank</p>	 <p>COLOR RANGE <b>TERRA</b> <b>OAK HAVANA</b> rustic colourful (original) ▪ WP Comfort Plank</p>
 <p>COLOR RANGE <b>TERRA</b> <b>OAK HAVANA</b> lively colourful (spektrum) ▪ WP Charisma Plank</p>	 <p>COLOR RANGE <b>NATUR</b> <b>OAK MANDEL</b> rustic (astig) ▪ WP Charisma Plank</p>	 <p>COLOR RANGE <b>NATUR</b> <b>OAK</b> calm (select) ▪ WP Charisma Plank, WP Performance Plank, WP Comfort Plank, WP Quadra 1800</p>	 <p>COLOR RANGE <b>NATUR</b> <b>OAK</b> lively (akzent) ▪ WP Grand Plank, WP Quadra 1800, WP Charisma Plank, WP Performance Plank</p>	 <p>COLOR RANGE <b>NATUR</b> <b>OAK</b> rustic (original*) ▪ WP Comfort Plank</p>
 <p>COLOR RANGE <b>NATUR</b> <b>OAK</b> rustic (essence) ▪ WP Grand Plank, WP Quadra 1800, WP Charisma Plank</p>	 <p>COLOR RANGE <b>NATUR</b> <b>OAK LIGHT</b> rustic (essence) ▪ WP Charisma Plank</p>	 <p>COLOR RANGE <b>NATUR</b> <b>OAK PURE</b> lively (accent) ▪ WP Charisma Plank, WP Quadra 1800</p>	 <p>COLOR RANGE <b>NATUR</b> <b>OAK PURE</b> rustic (essence) ▪ WP Quadra 1800</p>	 <p>COLOR RANGE <b>NATUR</b> <b>OAK PURE</b> rustic colourful (original) ▪ WP Comfort Plank</p>
 <p>COLOR RANGE <b>STONE</b> <b>OAK AUSTER</b> lively (akzent) ▪ WP Quadra 1800</p>	 <p>COLOR RANGE <b>STONE</b> <b>OAK AUSTER</b> rustic (essence) ▪ WP Charisma Plank</p>	 <p>COLOR RANGE <b>STONE</b> <b>OAK AUSTER</b> rustic colourful (original) ▪ WP Comfort Plank</p>	 <p>COLOR RANGE <b>STONE</b> <b>OAK COLORADO</b> DIAMOND ICE lively colourful (spektrum) ▪ WP Charisma Plank</p>	 <p>COLOR RANGE <b>STONE</b> <b>OAK COLORADO</b> DIAMOND ICE rustic colourful (original) ▪ WP Comfort Plank</p>
 <p>COLOR RANGE <b>STONE</b> <b>OAK KASCHMIR</b> calm (select) ▪ WP Charisma Plank, WP Comfort Plank, WP Quadra 1800</p>	 <p>COLOR RANGE <b>STONE</b> <b>OAK KASCHMIR</b> lively (accent) ▪ WP Charisma Plank</p>	 <p>COLOR RANGE <b>STONE</b> <b>OAK KASCHMIR</b> lively colourful (spektrum) ▪ WP Charisma Plank, WP Quadra 1800</p>	 <p>COLOR RANGE <b>STONE</b> <b>OAK KASCHMIR</b> rustic (essence) ▪ WP Charisma Plank</p>	 <p>COLOR RANGE <b>STONE</b> <b>OAK KASCHMIR</b> rustic colourful (original) ▪ WP Comfort Plank</p>

\*no sapwood



**Stock item delivery time:** promptly ex works (from 200 m<sup>2</sup> on request) | **iDesign Parkett delivery time (from 20 m<sup>2</sup> per item):** three to max. four weeks ex works (A flat LP surcharge of 400 EUR is billed under 20 m<sup>2</sup>). All deliveries are based on the General Terms and Conditions of Business of Weitzer Parkett. All rights reserved for changes, composition and printing errors.

 <p>COLOR RANGE <b>STONE</b> <b>OAK ICE</b> lively (accent)</p> <ul style="list-style-type: none"> <li>WP Charisma Plank</li> </ul>	 <p>COLOR RANGE <b>STONE</b> <b>OAK ICE</b> rustic (essence)</p> <ul style="list-style-type: none"> <li>WP Charisma Plank</li> </ul>	 <p>COLOR RANGE <b>STONE</b> <b>OAK SAVANNE</b> calm (select)</p> <ul style="list-style-type: none"> <li>WP Quadra 1800</li> </ul>	 <p>COLOR RANGE <b>STONE</b> <b>OAK SAVANNE</b> lively (accent)</p> <ul style="list-style-type: none"> <li>WP Quadra 1800</li> </ul>	 <p>COLOR RANGE <b>STONE</b> <b>OAK SAVANNE</b> lively colourful (original)</p> <ul style="list-style-type: none"> <li>WP Performance Plank</li> </ul>
 <p>COLOR RANGE <b>STONE</b> <b>OAK SAVANNE</b> rustic (essence)</p> <ul style="list-style-type: none"> <li>WP Charisma Plank</li> </ul>	 <p>COLOR RANGE <b>STONE</b> <b>OAK SAVANNE</b> rustic colourful (original)</p> <ul style="list-style-type: none"> <li>WP Comfort Plank</li> </ul>	 <p>COLOR RANGE <b>STONE</b> <b>ASH POLAR</b> rustic colourful (vibrant)</p> <ul style="list-style-type: none"> <li>WP Comfort Plank</li> </ul>	 <p>COLOR RANGE <b>STONE</b> <b>OAK POLAR</b> lively (accent)</p> <ul style="list-style-type: none"> <li>WP Charisma Plank</li> </ul>	 <p>COLOR RANGE <b>STONE</b> <b>OAK POLAR</b> lively colourful (spectrum)</p> <ul style="list-style-type: none"> <li>WP Charisma Plank</li> </ul>
 <p>COLOR RANGE <b>STONE</b> <b>OAK TAUPE</b> lively colourful (spectrum)</p> <ul style="list-style-type: none"> <li>WP Charisma Plank</li> </ul>	 <p>COLOR RANGE <b>STONE</b> <b>OAK TRÜFFELGRAU</b> calm (select)</p> <ul style="list-style-type: none"> <li>WP Charisma Plank</li> </ul>	 <p>COLOR RANGE <b>STONE</b> <b>OAK TRÜFFELGRAU</b> lively colourful (spectrum)</p> <ul style="list-style-type: none"> <li>WP Charisma Plank</li> </ul>	 <p>COLOR RANGE <b>SAND</b> <b>STONE PINE EDELWEISS</b> rustic colourful (original)</p> <ul style="list-style-type: none"> <li>WP Charisma Plank</li> </ul>	 <p>COLOR RANGE <b>SAND</b> <b>ASH</b> lively colourful (natural)</p> <ul style="list-style-type: none"> <li>WP Charisma Plank</li> </ul>

\*no sapwood



The grading overview serves as a rough orientation. To obtain a representative grading picture please see our official grading book or get info from our partner portal:  
<https://partner.weitzer-parkett.com>





## IMPERIAL PLANK

3-layer | Dimensions: 3500 x **350** x 18 mm | 1 Package = 2,45 m<sup>2</sup>WIDTH  
**350**

COLOUR RANGE TERRA		OAK KROKANT		ITEM NO.	EUR/m <sup>2</sup>	EDGE PROFILE 40 FOR STEPS EUR/lm Item No. 54291
	PVf rustic (vibrant)	bevelled	iDESIGN PARQUET*	43039	<b>165,11</b>	102,07
	PVf rustic (vibrant)	bevelled, brushed	iDESIGN PARQUET*	43040	<b>167,68</b>	103,10
	PVf rustic (vibrant)	bevelled, deep brushed	iDESIGN PARQUET*	43041	<b>169,74</b>	103,93
	PVf rustic (vibrant)	bevelled, intensely brushed	iDESIGN PARQUET*	51465	<b>180,04</b>	108,15
	PVf rustic (vibrant)	bevelled, scraped	iDESIGN PARQUET*	51503	<b>183,13</b>	109,39

COLOUR RANGE MATURE		OAK MANDEL		ITEM NO.	EUR/m <sup>2</sup>	EDGE PROFILE 40 FOR STEPS EUR/lm Item No. 54291
	PVf rustic (vibrant)	bevelled	iDESIGN PARQUET*	43411	<b>165,11</b>	102,07
	PVf rustic (vibrant)	bevelled, brushed	iDESIGN PARQUET*	43412	<b>167,68</b>	103,10
	PVf rustic (vibrant)	bevelled, deep brushed	iDESIGN PARQUET*	43413	<b>169,74</b>	103,93
	PVf rustic (vibrant)	bevelled, intensely brushed	iDESIGN PARQUET*	51753	<b>180,04</b>	108,15
	PVf rustic (vibrant)	bevelled, scraped	iDESIGN PARQUET*	51791	<b>183,13</b>	109,39

COLOUR RANGE MATURE		OAK		ITEM NO.	EUR/m <sup>2</sup>	EDGE PROFILE 40 FOR STEPS EUR/lm Item No. 54291
	PVf rustic (vibrant)	bevelled	iDESIGN PARQUET*	42202	<b>159,44</b>	96,72
	PVf rustic (vibrant)	bevelled, brushed	iDESIGN PARQUET*	42203	<b>162,02</b>	97,75
	PVf rustic (vibrant)	bevelled, deep brushed	iDESIGN PARQUET*	42204	<b>164,08</b>	98,57
	PVf rustic (vibrant)	bevelled, intensely brushed	iDESIGN PARQUET*	51900	<b>174,38</b>	102,79
	PVf rustic (vibrant)	bevelled, scraped	iDESIGN PARQUET*	51931	<b>177,47</b>	104,03

COLOUR RANGE MATURE		OAK PURE		ITEM NO.	EUR/m <sup>2</sup>	EDGE PROFILE 40 FOR STEPS EUR/lm Item No. 54291
	PVf rustic (vibrant)	bevelled	iDESIGN PARQUET*	50563	<b>165,11</b>	102,07
	PVf rustic (vibrant)	bevelled, brushed	iDESIGN PARQUET*	52011	<b>167,68</b>	103,10
	PVf rustic (vibrant)	bevelled, deep brushed	iDESIGN PARQUET*	52208	<b>169,74</b>	103,93
	PVf rustic (vibrant)	bevelled, intensely brushed	iDESIGN PARQUET*	52089	<b>180,04</b>	108,15
	PVf rustic (vibrant)	bevelled, scraped	iDESIGN PARQUET*	52128	<b>183,13</b>	109,39

SURCHARGE EDGE PROFILES		EUR/lm
EDGE PROFILE 40 SYLE		+ 3,60
EDGE PROFILE 58 SYLE		+ 5,67
EDGE PROFILE BLOCK SYLE (riser is supplied loose)		+ 86,42

All prices for WP Multi and Extras can be found on page 58



**Stock item delivery time:** promptly ex works (from 200 m<sup>2</sup> on request) | **iDesign Parkett delivery time (from 20 m<sup>2</sup> per item):** three to max. four weeks ex works (A flat LP surcharge of 400 EUR is billed under 20 m<sup>2</sup>). All deliveries are based on the General Terms and Conditions of Business of Weitzer Parkett. All rights reserved for changes, composition and printing errors.

## IMPERIAL PLANK

3-layer | Dimensions: 3500 x **350** x 18 mm | 1 Package = 2,45 m<sup>2</sup>

WIDTH  
**350**



COLOUR RANGE STONE		OAK AUSTER			ITEM NO.	EUR/m <sup>2</sup>	EDGE PROFILE 40 FOR STEPS EUR/lm Item No. 54291
	PVf	rustic (vibrant)	bevelled	iDESIGN PARQUET*	43771	<b>165,11</b>	102,07
	PVf	rustic (vibrant)	bevelled, brushed	iDESIGN PARQUET*	43772	<b>167,68</b>	103,10
	PVf	rustic (vibrant)	bevelled, deep brushed	iDESIGN PARQUET*	43773	<b>169,74</b>	103,93
	PVf	rustic (vibrant)	bevelled, intensely brushed	iDESIGN PARQUET*	49481	<b>180,04</b>	108,15
	PVf	rustic (vibrant)	bevelled, scraped	iDESIGN PARQUET*	52319	<b>183,13</b>	109,39

COLOUR RANGE STONE		OAK KASCHMIR			ITEM NO.	EUR/m <sup>2</sup>	EDGE PROFILE 40 FOR STEPS EUR/lm Item No. 54291
	PVf	rustic (vibrant)	bevelled	iDESIGN PARQUET*	43919	<b>165,11</b>	102,07
	PVf	rustic (vibrant)	bevelled, brushed	iDESIGN PARQUET*	43920	<b>167,68</b>	103,10
	PVf	rustic (vibrant)	bevelled, deep brushed	iDESIGN PARQUET*	43921	<b>169,74</b>	103,93
	PVf	rustic (vibrant)	bevelled, intensely brushed	iDESIGN PARQUET*	52409	<b>180,04</b>	108,15
	PVf	rustic (vibrant)	bevelled, scraped	iDESIGN PARQUET*	52445	<b>183,13</b>	109,39

COLOUR RANGE STONE		OAK ICE			ITEM NO.	EUR/m <sup>2</sup>	EDGE PROFILE 40 FOR STEPS EUR/lm Item No. 54291
	PVf	rustic (vibrant)	bevelled, deep brushed	iDESIGN PARQUET*	43976	<b>173,86</b>	105,68
	PVf	rustic (vibrant)	bevelled, intensely brushed	iDESIGN PARQUET*	53745	<b>184,16</b>	109,80
	PVf	rustic (vibrant)	bevelled, scraped	iDESIGN PARQUET*	50534	<b>187,25</b>	111,03

COLOUR RANGE STONE		OAK SAVANNE			ITEM NO.	EUR/m <sup>2</sup>	EDGE PROFILE 40 FOR STEPS EUR/lm Item No. 54291
	PVf	rustic (vibrant)	bevelled	iDESIGN PARQUET*	50591	<b>165,11</b>	102,07
	PVf	rustic (vibrant)	bevelled, brushed	iDESIGN PARQUET*	52521	<b>167,68</b>	103,10
	PVf	rustic (vibrant)	bevelled, deep brushed	iDESIGN PARQUET*	52752	<b>169,74</b>	103,93
	PVf	rustic (vibrant)	bevelled, intensely brushed	iDESIGN PARQUET*	52628	<b>180,04</b>	108,15
	PVf	rustic (vibrant)	bevelled, scraped	iDESIGN PARQUET*	52676	<b>183,13</b>	109,39

SURCHARGE EDGE PROFILES		EUR/lm
EDGE PROFILE 40 SYLE		+ 3,60
EDGE PROFILE 58 SYLE		+ 5,67
EDGE PROFILE BLOCK SYLE (riser is supplied loose)		+ 86,42

All prices for WP Multi and Extras can be found on page 58

## IMPERIAL PLANK

3-layer | Dimensions: 3500 x **350** x 18 mm | 1 Package = 2,45 m<sup>2</sup>WIDTH  
**350**

COLOUR RANGE STONE				ITEM NO.	EUR/m <sup>2</sup>	EDGE PROFILE 40 FOR STEPS EUR/m Item No. 54291
		<b>OAK POLAR</b>				
	PVf	rustic (vibrant)	bevelled	iDESIGN PARQUET® 52831	<b>169,23</b>	103,72
	PVf	rustic (vibrant)	bevelled, brushed	iDESIGN PARQUET® 40273	<b>171,80</b>	104,75
	PVf	rustic (vibrant)	bevelled, deep brushed	iDESIGN PARQUET® 52997	<b>173,86</b>	105,68
	PVf	rustic (vibrant)	bevelled, intensely brushed	iDESIGN PARQUET® 52881	<b>184,16</b>	109,80
	PVf	rustic (vibrant)	bevelled, scraped	iDESIGN PARQUET® 52917	<b>187,25</b>	111,03
		<b>OAK TRÜFFELGRAU</b>				
	PVf	rustic (vibrant)	bevelled	iDESIGN PARQUET® 63830	<b>169,23</b>	103,72
	PVf	rustic (vibrant)	bevelled	iDESIGN PARQUET® 63833	<b>187,25</b>	111,03
	PVf	rustic (vibrant)	bevelled, brushed	iDESIGN PARQUET® 63832	<b>171,80</b>	104,75
	PVf	rustic (vibrant)	bevelled, deep brushed	iDESIGN PARQUET® 63834	<b>173,86</b>	105,68
	PVf	rustic (vibrant)	bevelled, intensely brushed	iDESIGN PARQUET® 53381	<b>184,16</b>	109,80
		<b>OAK TAUPE</b>				
	PVf	rustic (vibrant)	bevelled	iDESIGN PARQUET® 53080	<b>165,11</b>	102,07
	PVf	rustic (vibrant)	bevelled, brushed	iDESIGN PARQUET® 40681	<b>167,68</b>	103,10
	PVf	rustic (vibrant)	bevelled, deep brushed	iDESIGN PARQUET® 53263	<b>169,74</b>	103,93
	PVf	rustic (vibrant)	bevelled, intensely brushed	iDESIGN PARQUET® 53145	<b>180,04</b>	108,15
	PVf	rustic (vibrant)	bevelled, scraped	iDESIGN PARQUET® 53185	<b>183,13</b>	109,39

## SURCHARGE EDGE PROFILES

EUR/m

EDGE PROFILE 40 SYLE

+ 3,60

EDGE PROFILE 58 SYLE

+ 5,67

EDGE PROFILE BLOCK SYLE (riser is supplied loose)

+ 86,42

All prices for WP Multi and Extras can be found on page 58



**Stock item delivery time:** promptly ex works (from 200 m<sup>2</sup> on request) | **iDesign Parkett delivery time (from 20 m<sup>2</sup> per item):** three to max. four weeks ex works (A flat LP surcharge of 400 EUR is billed under 20 m<sup>2</sup>). All deliveries are based on the General Terms and Conditions of Business of Weitzer Parkett. All rights reserved for changes, composition and printing errors.

## IMPERIAL PLANK

3-layer | Dimensions: 3500 x **300** x 18 mm | 1 Package = 2,10 m<sup>2</sup>

WIDTH  
**300**



COLOUR RANGE					ITEM NO.	EUR/m <sup>2</sup>	EDGE PROFILE 40 FOR STEPS EUR/lm Item No. 54291	
COLOUR RANGE TERRA		<b>OAK KROKANT</b>						
		PVf	rustic (vibrant)	bevelled	iDESIGN PARQUET*	43036	156,77	89,71
		PVf	rustic (vibrant)	bevelled, brushed	iDESIGN PARQUET*	43037	159,34	90,64
		PVf	rustic (vibrant)	bevelled, deep brushed	iDESIGN PARQUET*	43038	161,40	91,36
		PVf	rustic (vibrant)	bevelled, intensely brushed	iDESIGN PARQUET*	51464	171,70	94,86
		PVf	rustic (vibrant)	bevelled, scraped	iDESIGN PARQUET*	51502	174,79	96,00
COLOUR RANGE NATURE		<b>OAK MANDEL</b>						
		PVf	rustic (vibrant)	bevelled	iDESIGN PARQUET*	43408	156,77	89,71
		PVf	rustic (vibrant)	bevelled, brushed	iDESIGN PARQUET*	43409	159,34	90,64
		PVf	rustic (vibrant)	bevelled, deep brushed	iDESIGN PARQUET*	43410	161,40	91,36
		PVf	rustic (vibrant)	bevelled, intensely brushed	iDESIGN PARQUET*	51752	171,70	94,86
		PVf	rustic (vibrant)	bevelled, scraped	iDESIGN PARQUET*	51790	174,79	96,00
COLOUR RANGE NATURE		<b>OAK</b>						
		PVf	rustic (vibrant)	bevelled	iDESIGN PARQUET*	42198	151,10	84,67
		PVf	rustic (vibrant)	bevelled, brushed	iDESIGN PARQUET*	42199	153,68	85,59
		PVf	rustic (vibrant)	bevelled, deep brushed	iDESIGN PARQUET*	42200	155,74	86,31
		PVf	rustic (vibrant)	bevelled, intensely brushed	iDESIGN PARQUET*	51899	166,04	89,82
		PVf	rustic (vibrant)	bevelled, scraped	iDESIGN PARQUET*	51930	169,13	90,95
COLOUR RANGE NATURE		<b>OAK PURE</b>						
		PVf	rustic (vibrant)	bevelled	iDESIGN PARQUET*	50562	156,77	89,71
		PVf	rustic (vibrant)	bevelled, brushed	iDESIGN PARQUET*	52010	159,34	90,64
		PVf	rustic (vibrant)	bevelled, deep brushed	iDESIGN PARQUET*	52207	161,40	91,36
		PVf	rustic (vibrant)	bevelled, intensely brushed	iDESIGN PARQUET*	52088	171,70	94,86
		PVf	rustic (vibrant)	bevelled, scraped	iDESIGN PARQUET*	52127	174,79	96,00

SURCHARGE EDGE PROFILES		EUR/lm
EDGE PROFILE 40 SYLE		+ 3,60
EDGE PROFILE 58 SYLE		+ 5,67
EDGE PROFILE BLOCK SYLE (riser is supplied loose)		+ 86,42

All prices for WP Multi and Extras can be found on page 58



Stock item delivery time: promptly ex works (from 200 m<sup>2</sup> on request) | iDesign Parkett delivery time (from 20 m<sup>2</sup> per item): three to max. four weeks ex works (A flat LP surcharge of 400 EUR is billed under 20 m<sup>2</sup>). All deliveries are based on the General Terms and Conditions of Business of Weitzer Parkett. All rights reserved for changes, composition and printing errors.



## IMPERIAL PLANK

3-layer | Dimensions: 3500 x 300 x 18 mm | 1 Package = 2,10 m<sup>2</sup>WIDTH  
300

COLOUR RANGE STONE				ITEM NO.	EUR/m <sup>2</sup>	EDGE PROFILE 40 FOR STEPS EUR/lm Item No. 54291	
	<b>OAK AUSTER</b>						
	PVf	rustic (vibrant)	bevelled	iDESIGN PARQUET*	43768	156,77	89,71
	PVf	rustic (vibrant)	bevelled, brushed	iDESIGN PARQUET*	43769	159,34	90,64
	PVf	rustic (vibrant)	bevelled, deep brushed	iDESIGN PARQUET*	43770	161,40	91,36
	PVf	rustic (vibrant)	bevelled, intensely brushed	iDESIGN PARQUET*	52256	171,70	94,86
	PVf	rustic (vibrant)	bevelled, scraped	iDESIGN PARQUET*	52318	174,79	96,00
	<b>OAK KASCHMIR</b>						
	PVf	rustic (vibrant)	bevelled	iDESIGN PARQUET*	43916	156,77	89,71
	PVf	rustic (vibrant)	bevelled, brushed	iDESIGN PARQUET*	43917	159,34	90,64
	PVf	rustic (vibrant)	bevelled, deep brushed	iDESIGN PARQUET*	43918	161,40	91,36
	PVf	rustic (vibrant)	bevelled, intensely brushed	iDESIGN PARQUET*	52408	171,70	94,86
	PVf	rustic (vibrant)	bevelled, scraped	iDESIGN PARQUET*	52444	174,79	96,00
	<b>OAK ICE</b>						
	PVf	rustic (vibrant)	bevelled, deep brushed	iDESIGN PARQUET*	43975	165,52	92,80
	PVf	rustic (vibrant)	bevelled, intensely brushed	iDESIGN PARQUET*	53744	175,82	96,31
	PVf	rustic (vibrant)	bevelled, scraped	iDESIGN PARQUET*	50533	178,91	97,34
	<b>OAK SAVANNE</b>						
	PVf	rustic (vibrant)	bevelled	iDESIGN PARQUET*	50590	156,77	89,71
	PVf	rustic (vibrant)	bevelled, brushed	iDESIGN PARQUET*	52520	159,34	90,64
	PVf	rustic (vibrant)	bevelled, deep brushed	iDESIGN PARQUET*	52751	161,40	91,36
	PVf	rustic (vibrant)	bevelled, intensely brushed	iDESIGN PARQUET*	52627	171,70	94,86
	PVf	rustic (vibrant)	bevelled, scraped	iDESIGN PARQUET*	52675	174,79	96,00

## SURCHARGE EDGE PROFILES

EUR/lm

EDGE PROFILE 40 SYLE	+ 3,60
EDGE PROFILE 58 SYLE	+ 5,67
EDGE PROFILE BLOCK SYLE (riser is supplied loose)	+ 86,42

All prices for WP Multi and Extras can be found on page 58



**Stock item delivery time:** promptly ex works (from 200 m<sup>2</sup> on request) | **iDesign Parkett delivery time (from 20 m<sup>2</sup> per item):** three to max. four weeks ex works (A flat LP surcharge of 400 EUR is billed under 20 m<sup>2</sup>). All deliveries are based on the General Terms and Conditions of Business of Weitzer Parkett. All rights reserved for changes, composition and printing errors.

## IMPERIAL PLANK

3-layer | Dimensions: 3500 x **300** x 18 mm | 1 Package = 2,10 m<sup>2</sup>

WIDTH  
**300**



COLOUR RANGE	STONE				ITEM NO.	EUR/m <sup>2</sup>	EDGE PROFILE 40 FOR STEPS EUR/m Item No. 54291
		<b>OAK POLAR</b>					
	PVf	rustic (vibrant)	bevelled	iDESIGN PARQUET*	52826	<b>160,89</b>	91,16
	PVf	rustic (vibrant)	bevelled, brushed	iDESIGN PARQUET*	44083	<b>163,46</b>	92,08
	PVf	rustic (vibrant)	bevelled, deep brushed	iDESIGN PARQUET*	52996	<b>165,52</b>	92,80
	PVf	rustic (vibrant)	bevelled, intensely brushed	iDESIGN PARQUET*	52880	<b>175,82</b>	96,31
	PVf	rustic (vibrant)	bevelled, scraped	iDESIGN PARQUET*	52916	<b>178,91</b>	97,34

COLOUR RANGE	STONE				ITEM NO.	EUR/m <sup>2</sup>	EDGE PROFILE 40 FOR STEPS EUR/m Item No. 54291
		<b>OAK TRÜFFELGRAU</b>					
	PVf	rustic (vibrant)	bevelled	iDESIGN PARQUET*	63829	<b>160,89</b>	91,16
	PVf	rustic (vibrant)	bevelled, brushed	iDESIGN PARQUET*	63831	<b>163,46</b>	92,08
	PVf	rustic (vibrant)	bevelled, deep brushed	iDESIGN PARQUET*	53482	<b>165,52</b>	92,80
	PVf	rustic (vibrant)	bevelled, intensely brushed	iDESIGN PARQUET*	53380	<b>175,82</b>	96,31
	PVf	rustic (vibrant)	bevelled, scraped	iDESIGN PARQUET*	53418	<b>178,91</b>	97,34

COLOUR RANGE	STONE				ITEM NO.	EUR/m <sup>2</sup>	EDGE PROFILE 40 FOR STEPS EUR/m Item No. 54291
		<b>OAK TAUPE</b>					
	PVf	rustic (vibrant)	bevelled	iDESIGN PARQUET*	53079	<b>156,77</b>	89,71
	PVf	rustic (vibrant)	bevelled, brushed	iDESIGN PARQUET*	44165	<b>159,34</b>	90,64
	PVf	rustic (vibrant)	bevelled, deep brushed	iDESIGN PARQUET*	53262	<b>161,40</b>	91,36
	PVf	rustic (vibrant)	bevelled, intensely brushed	iDESIGN PARQUET*	53144	<b>171,70</b>	94,86
	PVf	rustic (vibrant)	bevelled, scraped	iDESIGN PARQUET*	53184	<b>174,79</b>	96,00

SURCHARGE EDGE PROFILES		EUR/m
<b>EDGE PROFILE 40 SYLE</b>		+ 3,60
<b>EDGE PROFILE 58 SYLE</b>		+ 5,67
<b>EDGE PROFILE BLOCK SYLE</b> (riser is supplied loose)		+ 86,42

All prices for WP Multi and Extras can be found on page 58



Stock item delivery time: promptly ex works (from 200 m<sup>2</sup> on request) | iDesign Parkett delivery time (from 20 m<sup>2</sup> per item): three to max. four weeks ex works (A flat LP surcharge of 400 EUR is billed under 20 m<sup>2</sup>.)  
All deliveries are based on the General Terms and Conditions of Business of Weitzer Parkett. All rights reserved for changes, composition and printing errors.

**IMPERIAL PLANK** (all widths)  
**WOODEN STAIRS WP MULTI**Prices apply for all colours, surface finishes,  
grades, and additional treatments.

PROFILE 40	SPECIES	TREAD PANEL without carrier panel   Item No.: 54290		RISER Item No.: 54281	WALL COVERING Item No.: 54315
		EURO/ STEPS/linear meters straight	EURO/ STEPS/linear meters L- and U-SHAPED	EURO/ STEPS/linear meters	EURO/ linear meters
	Oak	<b>123,70</b>	<b>145,33</b>	<b>76,12</b>	<b>104,85</b>
	White (RAL 9010)	-	-	<b>21,22</b>	-
<b>SURCHARGE</b>					
<b>PROFILE 40 STYLE</b>		<b>29,56</b>	<b>29,56</b>	-	-
<b>PROFILE 58 STYLE</b>		<b>31,62</b>	<b>31,62</b>	-	-
<b>PROFILE BLOCK STYLE</b>		<b>86,42</b>	<b>86,42</b>	Riser is included in the price and is supplied loose.	-
<b>Continuous top layer, no header joint</b> Up to product length		<b>+ 30 %</b>	<b>+ 30 %</b>	Riser panel will be delivered as one continuous piece of plank	<b>+ 30 %</b>
<b>Carrier panel</b> 6 mm, 17 mm or 27 mm		<b>15,04</b>	<b>15,04</b>	<b>9,17</b>	<b>9,17</b>
<b>Customization</b> Only possible with digital measuring system or stencils/moulds		<b>14,63</b>	<b>17,41</b>	<b>15,96</b>	Is customized
<b>Riser pre-drilled, including screws</b> Minimum thickness 19 mm		-	-	<b>13,70</b>	-

Orders for prefab tread panels possible using the WP Multi measurement sheet.  
Templates for download from Weitzer Parkett Partner Portal.

<b>WOODEN STAIRS WP MULTI   EXTRAS</b>				
<b>Multi Front Edge (FE)</b> <b>PROFILE 40, 40 STYLE, BLOCK STYLE</b> Item No.: 40272   right/left   available on request without a tongue	350 mm   EURO/pc.	<b>10,51</b>	600 mm   EURO/pc.	<b>13,49</b>
<b>Multi Front Edge (FE)</b> <b>PROFILE 58 STYLE</b> Item No.: 40272   right/left   available on request without a tongue	350 mm   EURO/pc.	<b>11,54</b>	600 mm   EURO/pc.	<b>14,52</b>
<b>Multi Wall Cover Moulding (WCM)</b> <b>PROFILE 40, 40 STYLE, 58 STYLE BLOCK STYLE</b> Item No.: 40281   right/left, straight/L- and U-shaped	350 mm   EURO/pc.	<b>10,51</b>	650 mm   EURO/pc.	<b>19,47</b>
<b>Multi Front Edge - Riser (FER)</b> <b>PROFILE 40/58 STYLE</b> for riser	white   EURO/lm Item No.: 40463	<b>6,90</b>	Species   EURO/lm Item No.: 40279	<b>12,77</b>
<b>Multi Landing Wall Cover Moulding</b> Item No.: 40627	40 x 14 mm   EURO/lm		<b>15,35</b>	
<b>Multi Front Edge (FE) execute</b> for treads including material	Tread Panel + wall covering EURO/pc.		<b>23,18</b>	
<b>Edge Profile for Stairs 40 (LEP)</b> Item No.: 54295 Dimensions: 40 mm x 14 mm   curvature/radius: 3 mm Fixed length: 2500 mm   including false tongue	Colour range <b>LAVA/TERRA</b> EURO/lm	<b>20,19</b>	remaining colour scheme EURO/lm	<b>16,07</b>

Further extras and detailed descriptions from page 141!



WP Multi wooden stairs delivery time **Stock items**: 12 working days from order confirmation ex works. Stair edge profile delivery time **Stock items**: 7 working days from order confirmation ex works.

WP Multi **iDESIGN PARKETT®** wooden staircase delivery time: 5-8 working weeks from order confirmation ex works. **iDESIGN PARKETT®** edge profile for stairs delivery time: 5-8 working weeks from order confirmation ex works.

# SIMPLE AND IMPRESSIVE

WP GRAND PLANK:  
3 WIDTHS -  
1 ROOM

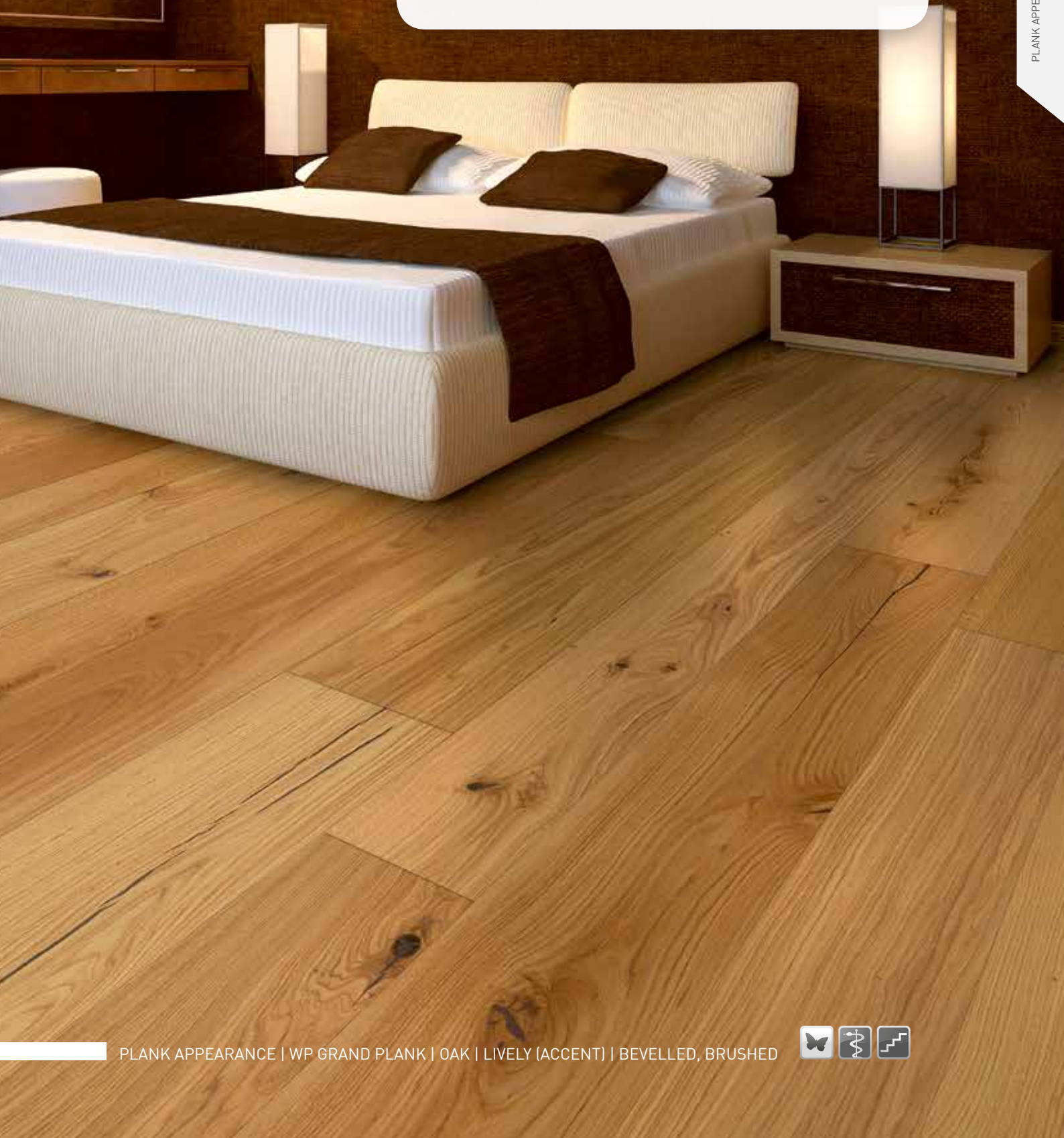



## WP GRAND PLANK

3-layer | Dimensions: 2400 x **280** x 14 mm | 1 Package = 4,03 m<sup>2</sup>WIDTH  
**280**

COLOUR RANGE				ITEM NO.	EUR/m <sup>2</sup>	EDGE PROFILE 40 FOR STEPS EUR/lm Item No. 54288	
TERRA	<b>OAK KROKANT</b>						
	PVf	lively (accent)	bevelled	iDESIGN PARQUET*	60307	99,19	66,23
	PVf	lively (accent)	bevelled, brushed	iDESIGN PARQUET*	60310	101,76	67,05
	PVf	lively (accent)	bevelled, deep brushed	iDESIGN PARQUET*	60316	103,82	67,77
	PVf	lively (accent)	bevelled, intensely brushed	iDESIGN PARQUET*	60319	114,12	71,07
	PVf	lively (accent)	bevelled, scraped	iDESIGN PARQUET*	60313	117,21	72,10
MATURE	<b>OAK MANDEL</b>						
	PVf	lively (accent)	bevelled	iDESIGN PARQUET*	60325	99,19	66,23
	PVf	lively (accent)	bevelled, brushed	iDESIGN PARQUET*	60328	101,76	67,05
	PVf	lively (accent)	bevelled, deep brushed	iDESIGN PARQUET*	60334	103,82	67,77
	PVf	lively (accent)	bevelled, intensely brushed	iDESIGN PARQUET*	60337	114,12	71,07
	PVf	lively (accent)	bevelled, scraped	iDESIGN PARQUET*	60331	117,21	72,10
MATURE	<b>OAK</b>						
	PVf	lively (accent)	bevelled	iDESIGN PARQUET*	60269	93,52	61,39
	PVf	lively (accent)	bevelled, brushed	STOCK ITEM	60263	89,92	60,15
	PVf	lively (accent)	bevelled, deep brushed	iDESIGN PARQUET*	60272	98,16	62,83
	PVf	lively (accent)	bevelled, intensely brushed	iDESIGN PARQUET*	60275	108,46	66,13
	PVf	lively (accent)	bevelled, scraped	iDESIGN PARQUET*	60278	111,55	67,16
	PVf	rustic (essence)	bevelled, brushed	STOCK ITEM	50709	78,59	56,55
MATURE	<b>OAK PURE</b>						
	PVf	lively (accent)	bevelled	iDESIGN PARQUET*	60364	99,19	66,23
	PVf	lively (accent)	bevelled, brushed	iDESIGN PARQUET*	60367	101,76	67,05
	PVf	lively (accent)	bevelled, deep brushed	iDESIGN PARQUET*	60376	103,82	67,77
	PVf	lively (accent)	bevelled, intensely brushed	iDESIGN PARQUET*	60379	114,12	71,07

## SURCHARGE EDGE PROFILES

EUR/lm

EDGE PROFILE 40 SYLE	+ 3,60
EDGE PROFILE 58 SYLE	+ 5,67
EDGE PROFILE BLOCK SYLE (riser is supplied loose)	+ 51,71

All prices for WP Multi and Extras can be found on page 69























**Stock item delivery time:** promptly ex works (from 200 m<sup>2</sup> on request) | **iDesign Parkett delivery time (from 20 m<sup>2</sup> per item):** three to max. four weeks ex works (A flat LP surcharge of 400 EUR is billed under 20 m<sup>2</sup>). All deliveries are based on the General Terms and Conditions of Business of Weitzer Parkett. All rights reserved for changes, composition and printing errors.

## WP GRAND PLANK

3-layer | Dimensions: 2400 x **280** x 14 mm | 1 Package = 4,03 m<sup>2</sup>

WIDTH  
**280**



COLOUR RANGE	ITEM NO.	EUR/m <sup>2</sup>	EDGE PROFILE 40 FOR STEPS EUR/lm Item No. 54288
	<b>OAK PURE</b>		
 PVf lively (accent)	bevelled, scraped	<b>iDESIGN PARQUET*</b> 60371	<b>117,21</b> 72,10
	<b>OAK AUSTER</b>		
 PVf lively (accent)	bevelled	<b>iDESIGN PARQUET*</b> 60237	<b>99,19</b> 66,23
 PVf lively (accent)	bevelled, brushed	<b>iDESIGN PARQUET*</b> 60246	<b>101,76</b> 67,05
 PVf lively (accent)	bevelled, deep brushed	<b>iDESIGN PARQUET*</b> 60256	<b>103,82</b> 67,77
 PVf lively (accent)	bevelled, intensely brushed	<b>iDESIGN PARQUET*</b> 60260	<b>114,12</b> 71,07
 PVf lively (accent)	bevelled, scraped	<b>iDESIGN PARQUET*</b> 60252	<b>117,21</b> 72,10
	<b>OAK KASCHMIR</b>		
 PVf lively (accent)	bevelled	<b>iDESIGN PARQUET*</b> 60290	<b>99,19</b> 66,23
 PVf lively (accent)	bevelled, brushed	<b>iDESIGN PARQUET*</b> 60293	<b>101,76</b> 67,05
 PVf lively (accent)	bevelled, deep brushed	<b>iDESIGN PARQUET*</b> 60297	<b>103,82</b> 67,77
 PVf lively (accent)	bevelled, intensely brushed	<b>iDESIGN PARQUET*</b> 60300	<b>114,12</b> 71,07
 PVf lively (accent)	bevelled, scraped	<b>iDESIGN PARQUET*</b> 60303	<b>117,21</b> 72,10
	<b>OAK ICE</b>		
 PVf lively (accent)	bevelled, deep brushed	<b>iDESIGN PARQUET*</b> 60281	<b>107,94</b> 69,11
 PVf lively (accent)	bevelled, intensely brushed	<b>iDESIGN PARQUET*</b> 60284	<b>118,24</b> 72,41
 PVf lively (accent)	bevelled, scraped	<b>iDESIGN PARQUET*</b> 60287	<b>121,33</b> 73,44
	<b>OAK SAVANNE</b>		
 PVf lively colourful (spectrum)	bevelled	<b>iDESIGN PARQUET*</b> 60387	<b>93,11</b> 64,27
 PVf lively colourful (spectrum)	bevelled, brushed	<b>iDESIGN PARQUET*</b> 60390	<b>95,69</b> 65,10

SURCHARGE EDGE PROFILES	EUR/lm
<b>EDGE PROFILE 40 SYLE</b>	+ 3,60
<b>EDGE PROFILE 58 SYLE</b>	+ 5,67
<b>EDGE PROFILE BLOCK SYLE</b> (riser is supplied loose)	+ 51,71

All prices for WP Multi and Extras can be found on page 69

## WP GRAND PLANK

3-layer | Dimensions: 2400 x **280** x 14 mm | 1 Package = 4,03 m<sup>2</sup>WIDTH  
**280**

COLOUR RANGE STONE				ITEM NO.	EUR/m <sup>2</sup>	EDGE PROFILE 40 FOR STEPS EUR/lm Item No. 54288
		<b>OAK SAVANNE</b>				
	PVf lively colourful (spectrum)	bevelled, deep brushed	iDESIGN PARQUET*	60396	<b>97,75</b>	65,82
	PVf lively colourful (spectrum)	bevelled, intensely brushed	iDESIGN PARQUET*	60399	<b>108,05</b>	69,11
	PVf lively colourful (spectrum)	bevelled, scraped	iDESIGN PARQUET*	60393	<b>111,14</b>	70,14
		<b>OAK POLAR</b>				
	PVf lively (accent)	bevelled	iDESIGN PARQUET*	60346	<b>103,31</b>	67,57
	PVf lively (accent)	bevelled, brushed	iDESIGN PARQUET*	60350	<b>105,88</b>	68,39
	PVf lively (accent)	bevelled, deep brushed	iDESIGN PARQUET*	60358	<b>107,94</b>	69,11
	PVf lively (accent)	bevelled, intensely brushed	iDESIGN PARQUET*	60361	<b>118,24</b>	72,41
	PVf lively (accent)	bevelled, scraped	iDESIGN PARQUET*	60355	<b>121,33</b>	73,44
		<b>OAK TRÜFFELGRAU</b>				
	PVf lively (accent)	bevelled	iDESIGN PARQUET*	60417	<b>103,31</b>	67,57
	PVf lively (accent)	bevelled, brushed	iDESIGN PARQUET*	63808	<b>105,88</b>	68,39
	PVf lively (accent)	bevelled, deep brushed	iDESIGN PARQUET*	63812	<b>107,94</b>	69,11
	PVf lively (accent)	bevelled, intensely brushed	iDESIGN PARQUET*	63815	<b>118,24</b>	72,41
	PVf lively (accent)	bevelled, scraped	iDESIGN PARQUET*	60423	<b>121,33</b>	73,44
		<b>OAK TAUPE</b>				
	PVf lively (accent)	bevelled	iDESIGN PARQUET*	60402	<b>99,19</b>	66,23
	PVf lively (accent)	bevelled, brushed	iDESIGN PARQUET*	60405	<b>101,76</b>	67,05
	PVf lively (accent)	bevelled, deep brushed	iDESIGN PARQUET*	60411	<b>103,82</b>	67,77
	PVf lively (accent)	bevelled, intensely brushed	iDESIGN PARQUET*	60414	<b>114,12</b>	71,07
	PVf lively (accent)	bevelled, scraped	iDESIGN PARQUET*	60408	<b>117,21</b>	72,10

## SURCHARGE EDGE PROFILES

EUR/lm

## EDGE PROFILE 40 SYLE

+ 3,60

## EDGE PROFILE 58 SYLE

+ 5,67

## EDGE PROFILE BLOCK SYLE (riser is supplied loose)

+ 51,71

All prices for WP Multi and Extras can be found on page 69



**Stock item delivery time:** promptly ex works (from 200 m<sup>2</sup> on request) | **iDesign Parkett delivery time (from 20 m<sup>2</sup> per item):** three to max. four weeks ex works (A flat LP surcharge of 400 EUR is billed under 20 m<sup>2</sup>). All deliveries are based on the General Terms and Conditions of Business of Weitzer Parkett. All rights reserved for changes, composition and printing errors.

## WP GRAND PLANK

3-layer | Dimensions: 2400 x **240** x 14 mm | 1 Package = 3,46 m<sup>2</sup>

WIDTH  
**240**



COLOUR RANGE TERRA		OAK KROKANT			ITEM NO.	EUR/m <sup>2</sup>	EDGE PROFILE 40 FOR STEPS EUR/lm Item No. 54288
	PVf	lively (accent)	bevelled	iDESIGN PARQUET*	60306	<b>93,01</b>	59,95
	PVf	lively (accent)	bevelled, brushed	iDESIGN PARQUET*	60309	<b>95,58</b>	60,67
	PVf	lively (accent)	bevelled, deep brushed	iDESIGN PARQUET*	60315	<b>97,64</b>	61,29
	PVf	lively (accent)	bevelled, intensely brushed	iDESIGN PARQUET*	60318	<b>107,94</b>	64,07
	PVf	lively (accent)	bevelled, scraped	iDESIGN PARQUET*	60312	<b>111,03</b>	64,99

COLOUR RANGE MATURE		OAK MANDEL			ITEM NO.	EUR/m <sup>2</sup>	EDGE PROFILE 40 FOR STEPS EUR/lm Item No. 54288
	PVf	lively (accent)	bevelled	iDESIGN PARQUET*	60324	<b>93,01</b>	59,95
	PVf	lively (accent)	bevelled, brushed	iDESIGN PARQUET*	60327	<b>95,58</b>	60,67
	PVf	lively (accent)	bevelled, deep brushed	iDESIGN PARQUET*	60333	<b>97,64</b>	61,29
	PVf	lively (accent)	bevelled, intensely brushed	iDESIGN PARQUET*	60336	<b>107,94</b>	64,07
	PVf	lively (accent)	bevelled, scraped	iDESIGN PARQUET*	60330	<b>111,03</b>	64,99

COLOUR RANGE MATURE		OAK			ITEM NO.	EUR/m <sup>2</sup>	EDGE PROFILE 40 FOR STEPS EUR/lm Item No. 54288
	PVf	lively (accent)	bevelled	iDESIGN PARQUET*	60268	<b>87,34</b>	55,31
	PVf	lively (accent)	bevelled, brushed	<b>STOCK ITEM</b>	60262	<b>83,74</b>	54,38
	PVf	lively (accent)	bevelled, deep brushed	iDESIGN PARQUET*	60271	<b>91,98</b>	56,65
	PVf	lively (accent)	bevelled, intensely brushed	iDESIGN PARQUET*	60274	<b>102,28</b>	59,43
	PVf	lively (accent)	bevelled, scraped	iDESIGN PARQUET*	60277	<b>105,37</b>	60,36
	PVf	rustic (essence)	bevelled, brushed	<b>STOCK ITEM</b>	50698	<b>73,23</b>	51,40

COLOUR RANGE MATURE		OAK PURE			ITEM NO.	EUR/m <sup>2</sup>	EDGE PROFILE 40 FOR STEPS EUR/lm Item No. 54288
	PVf	lively (accent)	bevelled	iDESIGN PARQUET*	60363	<b>93,01</b>	59,95
	PVf	lively (accent)	bevelled, brushed	iDESIGN PARQUET*	60366	<b>95,58</b>	60,67
	PVf	lively (accent)	bevelled, deep brushed	iDESIGN PARQUET*	60374	<b>97,64</b>	61,29
	PVf	lively (accent)	bevelled, intensely brushed	iDESIGN PARQUET*	60378	<b>107,94</b>	64,07

SURCHARGE EDGE PROFILES		EUR/lm
EDGE PROFILE 40 SYLE		+ 3,60
EDGE PROFILE 58 SYLE		+ 5,67
EDGE PROFILE BLOCK SYLE (riser is supplied loose)		+ 51,71

All prices for WP Multi and Extras can be found on page 69

## WP GRAND PLANK

3-layer | Dimensions: 2400 x 240 x 14 mm | 1 Package = 3,46 m<sup>2</sup>WIDTH  
240

COLOUR RANGE				ITEM NO.	EUR/m <sup>2</sup>	EDGE PROFILE 40 FOR STEPS EUR/lm Item No. 54288	
COLOUR RANGE: MATURE		<b>OAK PURE</b>					
	PVf	lively (accent)	bevelled, scraped	iDESIGN PARQUET*	60370	111,03	64,99
COLOUR RANGE: STONE		<b>OAK AUSTER</b>					
	PVf	lively (accent)	bevelled	iDESIGN PARQUET*	60235	93,01	59,95
	PVf	lively (accent)	bevelled, brushed	iDESIGN PARQUET*	60244	95,58	60,67
	PVf	lively (accent)	bevelled, deep brushed	iDESIGN PARQUET*	60254	97,64	61,29
	PVf	lively (accent)	bevelled, intensely brushed	iDESIGN PARQUET*	60259	107,94	64,07
	PVf	lively (accent)	bevelled, scraped	iDESIGN PARQUET*	60251	111,03	64,99
COLOUR RANGE: STONE		<b>OAK KASCHMIR</b>					
	PVf	lively (accent)	bevelled	iDESIGN PARQUET*	60289	93,01	59,95
	PVf	lively (accent)	bevelled, brushed	iDESIGN PARQUET*	60292	95,58	60,67
	PVf	lively (accent)	bevelled, deep brushed	iDESIGN PARQUET*	60296	97,64	61,29
	PVf	lively (accent)	bevelled, intensely brushed	iDESIGN PARQUET*	60299	107,94	64,07
	PVf	lively (accent)	bevelled, scraped	iDESIGN PARQUET*	60302	111,03	64,99
COLOUR RANGE: STONE		<b>OAK ICE</b>					
	PVf	lively (accent)	bevelled, deep brushed	iDESIGN PARQUET*	60280	101,76	62,42
	PVf	lively (accent)	bevelled, intensely brushed	iDESIGN PARQUET*	60283	112,06	65,20
	PVf	lively (accent)	bevelled, scraped	iDESIGN PARQUET*	60286	115,15	66,13
COLOUR RANGE: STONE		<b>OAK SAVANNE</b>					
	PVf	lively colourful (spectrum)	bevelled	iDESIGN PARQUET*	60386	87,34	58,40
PVf	lively colourful (spectrum)	bevelled, brushed	iDESIGN PARQUET*	60389	89,92	59,12	

## SURCHARGE EDGE PROFILES

EUR/lm

EDGE PROFILE 40 SYLE

+ 3,60

EDGE PROFILE 58 SYLE

+ 5,67

EDGE PROFILE BLOCK SYLE (riser is supplied loose)

+ 51,71

All prices for WP Multi and Extras can be found on page 69



**Stock item delivery time:** promptly ex works (from 200 m<sup>2</sup> on request) | **iDesign Parkett delivery time (from 20 m<sup>2</sup> per item):** three to max. four weeks ex works (A flat LP surcharge of 400 EUR is billed under 20 m<sup>2</sup>). All deliveries are based on the General Terms and Conditions of Business of Weitzer Parkett. All rights reserved for changes, composition and printing errors.



## WP GRAND PLANK

3-layer | Dimensions: 2400 x **240** x 14 mm | 1 Package = 3,46 m<sup>2</sup>

WIDTH  
**240**



COLOUR RANGE STONE					ITEM NO.	EUR/m <sup>2</sup>	EDGE PROFILE 40 FOR STEPS EUR/lm Item No. 54288
		<b>OAK SAVANNE</b>					
	PvF	lively colourful (spectrum)	bevelled, deep brushed	iDESIGN PARQUET*	60395	<b>91,98</b>	59,74
	PvF	lively colourful (spectrum)	bevelled, intensely brushed	iDESIGN PARQUET*	60398	<b>102,28</b>	62,52
	PvF	lively colourful (spectrum)	bevelled, scraped	iDESIGN PARQUET*	60392	<b>105,37</b>	63,45
		<b>OAK POLAR</b>					
	PvF	lively (accent)	bevelled	iDESIGN PARQUET*	60345	<b>97,13</b>	61,08
	PvF	lively (accent)	bevelled, brushed	iDESIGN PARQUET*	60349	<b>99,70</b>	61,80
	PvF	lively (accent)	bevelled, deep brushed	iDESIGN PARQUET*	60357	<b>101,76</b>	62,42
	PvF	lively (accent)	bevelled, intensely brushed	iDESIGN PARQUET*	60360	<b>112,06</b>	65,20
	PvF	lively (accent)	bevelled, scraped	iDESIGN PARQUET*	60354	<b>115,15</b>	66,13
		<b>OAK TRÜFFELGRAU</b>					
	PvF	lively (accent)	bevelled	iDESIGN PARQUET*	60416	<b>97,13</b>	61,08
	PvF	lively (accent)	bevelled, brushed	iDESIGN PARQUET*	63807	<b>99,70</b>	61,80
	PvF	lively (accent)	bevelled, deep brushed	iDESIGN PARQUET*	63811	<b>101,76</b>	62,42
	PvF	lively (accent)	bevelled, intensely brushed	iDESIGN PARQUET*	63814	<b>112,06</b>	65,20
	PvF	lively (accent)	bevelled, scraped	iDESIGN PARQUET*	63809	<b>115,15</b>	66,13
		<b>OAK TAUPE</b>					
	PvF	lively (accent)	bevelled	iDESIGN PARQUET*	60401	<b>93,01</b>	59,95
	PvF	lively (accent)	bevelled, brushed	iDESIGN PARQUET*	60404	<b>95,58</b>	60,67
	PvF	lively (accent)	bevelled, deep brushed	iDESIGN PARQUET*	60410	<b>97,64</b>	61,29
	PvF	lively (accent)	bevelled, intensely brushed	iDESIGN PARQUET*	60413	<b>107,94</b>	64,07
	PvF	lively (accent)	bevelled, scraped	iDESIGN PARQUET*	60407	<b>111,03</b>	64,99

SURCHARGE EDGE PROFILES		EUR/lm
EDGE PROFILE 40 SYLE		+ 3,60
EDGE PROFILE 58 SYLE		+ 5,67
EDGE PROFILE BLOCK SYLE (riser is supplied loose)		+ 51,71

All prices for WP Multi and Extras can be found on page 69

## WP GRAND PLANK

3-layer | Dimensions: 2400 x 193 x 14 mm | 1 Package = 2,78 m<sup>2</sup>WIDTH  
193

COLOUR RANGE				ITEM NO.	EUR/m <sup>2</sup>	EDGE PROFILE 40 FOR STEPS EUR/lm Item No. 54288	
TERRA	OAK KROKANT						
		PVf lively (accent)	bevelled	iDESIGN PARQUET*	60305	89,40	42,33
		PVf lively (accent)	bevelled, brushed	iDESIGN PARQUET*	60308	91,98	42,95
		PVf lively (accent)	bevelled, deep brushed	iDESIGN PARQUET*	60314	94,04	43,36
		PVf lively (accent)	bevelled, intensely brushed	iDESIGN PARQUET*	60317	104,34	45,73
		PVf lively (accent)	bevelled, scraped	iDESIGN PARQUET*	60311	107,43	46,35
MATURE	OAK MANDEL						
		PVf lively (accent)	bevelled	iDESIGN PARQUET*	60323	89,40	42,33
		PVf lively (accent)	bevelled, brushed	iDESIGN PARQUET*	60326	91,98	42,95
		PVf lively (accent)	bevelled, deep brushed	iDESIGN PARQUET*	60332	94,04	43,36
		PVf lively (accent)	bevelled, intensely brushed	iDESIGN PARQUET*	60335	104,34	45,73
		PVf lively (accent)	bevelled, scraped	iDESIGN PARQUET*	60329	107,43	46,35
MATURE	OAK						
		PVf lively (accent)	bevelled	iDESIGN PARQUET*	60267	83,74	38,01
		PVf lively (accent)	bevelled, brushed	STOCK ITEM	60261	80,13	37,18
		PVf lively (accent)	bevelled, deep brushed	iDESIGN PARQUET*	60270	88,37	39,04
		PVf lively (accent)	bevelled, intensely brushed	iDESIGN PARQUET*	60273	98,67	41,30
		PVf lively (accent)	bevelled, scraped	iDESIGN PARQUET*	60276	101,76	42,02
		PVf rustic (essence)	bevelled, brushed	STOCK ITEM	50690	70,14	35,02
MATURE	OAK PURE						
		PVf lively (accent)	bevelled	iDESIGN PARQUET*	60362	89,40	42,33
		PVf lively (accent)	bevelled, brushed	iDESIGN PARQUET*	60365	91,98	42,95
		PVf lively (accent)	bevelled, deep brushed	iDESIGN PARQUET*	60373	94,04	43,36
		PVf lively (accent)	bevelled, intensely brushed	iDESIGN PARQUET*	60377	104,34	45,73

## SURCHARGE EDGE PROFILES

EUR/lm

EDGE PROFILE 40 SYLE	+ 3,60
EDGE PROFILE 58 SYLE	+ 5,67
EDGE PROFILE BLOCK SYLE (riser is supplied loose)	+ 51,71

All prices for WP Multi and Extras can be found on page 69























**Stock item delivery time:** promptly ex works (from 200 m<sup>2</sup> on request) | **iDesign Parkett delivery time (from 20 m<sup>2</sup> per item):** three to max. four weeks ex works (A flat LP surcharge of 400 EUR is billed under 20 m<sup>2</sup>). All deliveries are based on the General Terms and Conditions of Business of Weitzer Parkett. All rights reserved for changes, composition and printing errors.

## WP GRAND PLANK

3-layer | Dimensions: 2400 x 193 x 14 mm | 1 Package = 2,78 m<sup>2</sup>

WIDTH  
**193**



COLOUR RANGE	ITEM NO.	EUR/m <sup>2</sup>	EDGE PROFILE 40 FOR STEPS EUR/lm Item No. 54288
	<b>OAK PURE</b>		
 PVf lively (accent)	bevelled, scraped	<b>iDESIGN PARQUET*</b> 60369	<b>107,43</b> 46,35
	<b>OAK AUSTER</b>		
 PVf lively (accent)	bevelled	<b>iDESIGN PARQUET*</b> 60233	<b>89,40</b> 42,33
 PVf lively (accent)	bevelled, brushed	<b>iDESIGN PARQUET*</b> 60241	<b>91,98</b> 42,95
 PVf lively (accent)	bevelled, deep brushed	<b>iDESIGN PARQUET*</b> 60253	<b>94,04</b> 43,36
 PVf lively (accent)	bevelled, intensely brushed	<b>iDESIGN PARQUET*</b> 60258	<b>104,34</b> 45,73
 PVf lively (accent)	bevelled, scraped	<b>iDESIGN PARQUET*</b> 60249	<b>107,43</b> 46,35
	<b>OAK KASCHMIR</b>		
 PVf lively (accent)	bevelled	<b>iDESIGN PARQUET*</b> 60288	<b>89,40</b> 42,33
 PVf lively (accent)	bevelled, brushed	<b>iDESIGN PARQUET*</b> 60291	<b>91,98</b> 42,95
 PVf lively (accent)	bevelled, deep brushed	<b>iDESIGN PARQUET*</b> 60295	<b>94,04</b> 43,36
 PVf lively (accent)	bevelled, intensely brushed	<b>iDESIGN PARQUET*</b> 60298	<b>104,34</b> 45,73
 PVf lively (accent)	bevelled, scraped	<b>iDESIGN PARQUET*</b> 60301	<b>107,43</b> 46,35
	<b>OAK ICE</b>		
 PVf lively (accent)	bevelled, deep brushed	<b>iDESIGN PARQUET*</b> 60279	<b>98,16</b> 44,29
 PVf lively (accent)	bevelled, intensely brushed	<b>iDESIGN PARQUET*</b> 60282	<b>108,46</b> 46,56
 PVf lively (accent)	bevelled, scraped	<b>iDESIGN PARQUET*</b> 60285	<b>111,55</b> 47,28
	<b>OAK SAVANNE</b>		
 PVf lively colourful (spectrum)	bevelled	<b>iDESIGN PARQUET*</b> 60385	<b>84,05</b> 41,20
 PVf lively colourful (spectrum)	bevelled, brushed	<b>iDESIGN PARQUET*</b> 60388	<b>86,62</b> 41,72

SURCHARGE EDGE PROFILES	EUR/lm
<b>EDGE PROFILE 40 SYLE</b>	+ 3,60
<b>EDGE PROFILE 58 SYLE</b>	+ 5,67
<b>EDGE PROFILE BLOCK SYLE</b> (riser is supplied loose)	+ 51,71

All prices for WP Multi and Extras can be found on page 69

## WP GRAND PLANK

3-layer | Dimensions: 2400 x **193** x 14 mm | 1 Package = 2,78 m<sup>2</sup>WIDTH  
**193**

COLOUR RANGE	STONE				ITEM NO.	EUR/m <sup>2</sup>	EDGE PROFILE 40 FOR STEPS EUR/lm Item No. 54288
		<b>OAK SAVANNE</b>					
	PVf	lively colourful (spectrum)	bevelled, deep brushed	iDESIGN PARQUET*	60394	<b>88,68</b>	42,23
	PVf	lively colourful (spectrum)	bevelled, intensely brushed	iDESIGN PARQUET*	60397	<b>98,98</b>	44,50
	PVf	lively colourful (spectrum)	bevelled, scraped	iDESIGN PARQUET*	60391	<b>102,07</b>	45,22
		<b>OAK POLAR</b>					
	PVf	lively (accent)	bevelled	iDESIGN PARQUET*	60342	<b>93,52</b>	43,26
	PVf	lively (accent)	bevelled, brushed	iDESIGN PARQUET*	60348	<b>96,10</b>	43,88
	PVf	lively (accent)	bevelled, deep brushed	iDESIGN PARQUET*	60356	<b>98,16</b>	44,29
	PVf	lively (accent)	bevelled, intensely brushed	iDESIGN PARQUET*	60359	<b>108,46</b>	46,56
	PVf	lively (accent)	bevelled, scraped	iDESIGN PARQUET*	60353	<b>111,55</b>	47,28
		<b>OAK TRÜFFELGRAU</b>					
	PVf	lively (accent)	bevelled	iDESIGN PARQUET*	60415	<b>93,52</b>	43,26
	PVf	lively (accent)	bevelled, brushed	iDESIGN PARQUET*	63806	<b>96,10</b>	43,88
	PVf	lively (accent)	bevelled, deep brushed	iDESIGN PARQUET*	63810	<b>98,16</b>	44,29
	PVf	lively (accent)	bevelled, intensely brushed	iDESIGN PARQUET*	63813	<b>108,46</b>	46,56
	PVf	lively (accent)	bevelled, scraped	iDESIGN PARQUET*	60421	<b>111,55</b>	47,28
		<b>OAK TAUPE</b>					
	PVf	lively (accent)	bevelled	iDESIGN PARQUET*	60400	<b>89,40</b>	42,33
	PVf	lively (accent)	bevelled, brushed	iDESIGN PARQUET*	60403	<b>91,98</b>	42,95
	PVf	lively (accent)	bevelled, deep brushed	iDESIGN PARQUET*	60409	<b>94,04</b>	43,36
	PVf	lively (accent)	bevelled, intensely brushed	iDESIGN PARQUET*	60412	<b>104,34</b>	45,73
	PVf	lively (accent)	bevelled, scraped	iDESIGN PARQUET*	60406	<b>107,43</b>	46,35

## SURCHARGE EDGE PROFILES

EUR/lm

EDGE PROFILE 40 SYLE

+ 3,60

EDGE PROFILE 58 SYLE

+ 5,67

EDGE PROFILE BLOCK SYLE (riser is supplied loose)

+ 51,71

All prices for WP Multi and Extras can be found on page 69



**Stock item delivery time:** promptly ex works (from 200 m<sup>2</sup> on request) | **iDesign Parkett delivery time (from 20 m<sup>2</sup> per item):** three to max. four weeks ex works (A flat LP surcharge of 400 EUR is billed under 20 m<sup>2</sup>). All deliveries are based on the General Terms and Conditions of Business of Weitzer Parkett. All rights reserved for changes, composition and printing errors.



## WP GRAND PLANK WOODEN STAIRS WP MULTI

Prices apply for all colours, surface finishes, grades, and additional treatments.

PROFILE 40	SPECIES	TREAD PANEL without carrier panel   Item No.: 54290		RISER Item No.: 54281	WALL COVERING Item No.: 54315
		EURO/ STEPS/linear meters straight	EURO/ STEPS/linear meters L- and U-SHAPED	EURO/ STEPS/linear meters	EURO/ linear meters
	Oak	<b>81,06</b>	<b>95,28</b>	<b>41,41</b>	<b>64,68</b>
	White (RAL 9010)	-	-	<b>21,22</b>	-
<b>SURCHARGE</b>					
<b>PROFILE 40 STYLE</b>		<b>14,42</b>	<b>14,42</b>	-	-
<b>PROFILE 58 STYLE</b>		<b>16,48</b>	<b>16,48</b>	Riser is included in the price and is supplied loose.	-
<b>PROFILE BLOCK STYLE</b>		<b>51,71</b>	<b>51,71</b>	Riser is included in the price and is supplied loose.	-
<b>Continuous top layer, no header joint</b> Up to product length		<b>+ 30 %</b>	<b>+ 30 %</b>	Riser panel will be delivered as one continuous piece of plank	<b>+ 30 %</b>
<b>Carrier panel</b> 6 mm, 17 mm or 27 mm		<b>15,04</b>	<b>15,04</b>	<b>9,17</b>	<b>9,17</b>
<b>Customization</b> Only possible with digital measuring system or stencils/moulds		<b>14,63</b>	<b>17,41</b>	<b>15,96</b>	Is customized
<b>Riser pre-drilled, including screws</b> Minimum thickness 19 mm		-	-	<b>13,70</b>	-
<b>SURCHARGE</b>		<b>TREAD PANEL</b> without carrier panel   Item No.: 54339		<b>RISER</b> Item No.: 54340	<b>WALL COVERING</b> Item No.: 54313
<b>iDESIGN PARKETT®</b> all species		<b>6,18</b>	<b>6,18</b>	<b>6,18</b>	<b>6,18</b>

Orders for prefab tread panels possible using the WP Multi measurement sheet.  
Templates for download from Weitzer Parkett Partner Portal.

WOODEN STAIRS WP MULTI   EXTRAS				
<b>Multi Front Edge (FE)</b> <b>PROFILE 40, 40 STYLE, BLOCK STYLE</b> Item No.: 40272   right/left   available on request without a tongue	350 mm   EURO/pc.	<b>10,51</b>	600 mm   EURO/pc.	<b>13,49</b>
<b>Multi Front Edge (FE)</b> <b>PROFILE 58 STYLE</b> Item No.: 40272   right/left   available on request without a tongue	350 mm   EURO/pc.	<b>11,54</b>	600 mm   EURO/pc.	<b>14,52</b>
<b>Multi Wall Cover Moulding (WCM)</b> <b>PROFILE 40, 40 STYLE, 58 STYLE BLOCK STYLE</b> Item No.: 40281   right/left, straight/L- and U-shaped	350 mm   EURO/pc.	<b>10,51</b>	650 mm   EURO/pc.	<b>19,47</b>
<b>Multi Front Edge - Riser (FER)</b> <b>PROFILE 40/58 STYLE</b> for riser	white   EURO/lm Item No.: 40463	<b>6,90</b>	Species   EURO/lm Item No.: 40279	<b>12,77</b>
<b>Multi Landing Wall Cover Moulding</b> Item No.: 40627	40 x 14 mm   EURO/lm		<b>15,35</b>	
<b>Multi Front Edge (FE) execute</b> for treads including material	Tread Panel + wall covering EURO/pc.		<b>23,18</b>	
<b>Edge Profile for Stairs 40 (LEP)</b> Item No.: 54295 Dimensions: 40 mm x 14 mm   curvature/radius: 3 mm Fixed length: 2500 mm	Colour range <b>LAVA/TERRA</b> EURO/lm	<b>20,19</b>	remaining colour scheme EURO/lm	<b>16,07</b>

Further extras and detailed descriptions from page 141!



WP Multi wooden stairs delivery time **Stock items**: 12 working days from order confirmation ex works. Stair edge profile delivery time **Stock items**: 7 working days from order confirmation ex works.

WP Multi **iDESIGN PARKETT®** wooden staircase delivery time: 5-8 working weeks from order confirmation ex works. **iDESIGN PARKETT®** edge profile for stairs delivery time: 5-8 working weeks from order confirmation ex works.



## WP CHARISMA PLANK

3-layer | Dimensions: 2245 x 193 x 14 mm | 1 Package = 2,60 m<sup>2</sup>

COLOUR RANGE				ITEM NO.	EUR/m <sup>2</sup>	EDGE PROFILE 40 FOR STEPS EUR/lm Item No. 29889	
LAVA	FUMED OAK MELANGE						
	PVf	lively (original*)	bevelled	iDESIGN PARQUET*	42842	117,32	49,54
	PVf	lively (original*)	bevelled, brushed	iDESIGN PARQUET*	42839	119,89	50,06
	PVf	lively (original*)	bevelled, deep brushed	iDESIGN PARQUET*	42840	121,95	50,57
	PVf	lively (original*)	bevelled, intensely brushed	iDESIGN PARQUET*	50648	132,25	52,84
PVf	lively (original*)	bevelled, scraped	iDESIGN PARQUET*	50649	135,34	53,56	
LAVA	FUMED OAK						
	PA+	lively (original*)	bevelled, brushed	STOCK ITEM	20934	101,87	46,14
	PVf	lively (original*)	bevelled	STOCK ITEM	29152	101,35	45,94
	PVf	lively (original*)	bevelled, brushed	iDESIGN PARQUET*	29151	110,11	47,90
	PVf	lively (original*)	bevelled, deep brushed	iDESIGN PARQUET*	42078	112,17	48,41
	PVf	lively (original*)	bevelled, intensely brushed	iDESIGN PARQUET*	50672	122,47	50,68
PVf	lively (original*)	bevelled, scraped	iDESIGN PARQUET*	50673	125,56	51,40	
TERRA	OAK COGNAC						
PVf	rustic (essence)	bevelled, scraped	COLLECTION HP	49438	87,24	42,54	
TERRA	OAK COFFEE						
	PA+	lively (original*)	bevelled, brushed	STOCK ITEM	20936	101,87	46,14
	PVf	lively (original*)	bevelled	iDESIGN PARQUET*	29147	107,53	47,38
PVf	lively (original*)	bevelled, brushed	iDESIGN PARQUET*	42080	110,11	47,90	
TERRA	OAK HAVANA						
PA+	lively colourful (spectrum)	bevelled	STOCK ITEM	26822	71,07	38,93	
WP PLANK SWITCH		WP Charisma Plank in all colours, gradings and surfaces		60019	126,69		

## SURCHARGE EDGE PROFILES

EUR/lm

EDGE PROFILE 40 SYLE	+ 3,60
EDGE PROFILE 58 SYLE	+ 5,67
EDGE PROFILE BLOCK SYLE (riser is supplied loose)	+ 51,09

HP = Healthy-plank collection. All of the products in the collection are **Stock items**MFP = Maintenance-free plank collection. All of the products in the collection are **Stock items** \*no sapwood

All prices for WP Multi and Extras can be found on page 78



**Stock item delivery time:** promptly ex works (from 200 m<sup>2</sup> on request) | **iDesign Parkett delivery time (from 20 m<sup>2</sup> per item):** three to max. four weeks ex works (A flat LP surcharge of 400 EUR is billed under 20 m<sup>2</sup>). All deliveries are based on the General Terms and Conditions of Business of Weitzer Parkett. All rights reserved for changes, composition and printing errors.

## WP CHARISMA PLANK

3-layer | Dimensions: 2245 x 193 x 14 mm | 1 Package = 2,60 m<sup>2</sup>



COLOUR RANGE TERRA	OAK KROKANT		ITEM NO.	EUR/m <sup>2</sup>	EDGE PROFILE 40 FOR STEPS EUR/lm Item No. 29889
--------------------	-------------	--	----------	--------------------	---

	PVf	calm (select)	bevelled	iDESIGN PARQUET*	42934	102,07	45,84
	PVf	calm (select)	bevelled, brushed	iDESIGN PARQUET*	42935	104,65	46,45
	PVf	calm (select)	bevelled, deep brushed	iDESIGN PARQUET*	42936	106,71	46,87
	PVf	calm (select)	bevelled, scraped	iDESIGN PARQUET*	51532	120,10	49,85
	PVf	lively (accent)	bevelled	iDESIGN PARQUET*	42942	86,01	42,23
	PVf	lively (accent)	bevelled, brushed	iDESIGN PARQUET*	42943	88,58	42,85
	PVf	lively (accent)	bevelled, deep brushed	iDESIGN PARQUET*	42944	90,64	43,26
	PVf	lively (accent)	bevelled, scraped	iDESIGN PARQUET*	49516	104,03	46,25
	PVf	rustic (essence)	bevelled	iDESIGN PARQUET*	42957	75,40	39,86
	PVf	rustic (essence)	bevelled, brushed	iDESIGN PARQUET*	42958	77,97	40,48
	PVf	rustic (essence)	bevelled, deep brushed	iDESIGN PARQUET*	42959	80,03	40,89
	PVf	rustic (essence)	bevelled, intensely brushed	iDESIGN PARQUET*	51496	90,33	43,26
	PVf	rustic (essence)	bevelled, scraped	iDESIGN PARQUET*	51534	93,42	43,88

COLOUR RANGE NATURE	OAK MANDEL		ITEM NO.	EUR/m <sup>2</sup>	EDGE PROFILE 40 FOR STEPS EUR/lm Item No. 29889
---------------------	------------	--	----------	--------------------	---

	PVf	calm (select)	bevelled	iDESIGN PARQUET*	29283	102,07	45,84
	PVf	calm (select)	bevelled, brushed	iDESIGN PARQUET*	29284	104,65	46,45
	PVf	calm (select)	bevelled, deep brushed	iDESIGN PARQUET*	43353	106,71	46,87
	PVf	calm (select)	bevelled, scraped	iDESIGN PARQUET*	51815	120,10	49,85
	PVf	lively (accent)	bevelled	iDESIGN PARQUET*	29161	86,01	42,23
	PVf	lively (accent)	bevelled, brushed	iDESIGN PARQUET*	29162	88,58	42,85
	PVf	lively (accent)	bevelled, deep brushed	iDESIGN PARQUET*	43358	90,64	43,26
	PVf	lively (accent)	bevelled, scraped	iDESIGN PARQUET*	51816	104,03	46,25
	PA+	rustic (essence)	bevelled, brushed	<b>STOCK ITEM</b>	51886	68,19	38,32
	PVf	rustic (essence)	bevelled	iDESIGN PARQUET*	29173	75,40	39,86
	PVf	rustic (essence)	bevelled, brushed	<b>COLLECTION HP</b>	29174	71,79	39,14
	PVf	rustic (essence)	bevelled, deep brushed	iDESIGN PARQUET*	43368	80,03	40,89
	PVf	rustic (essence)	bevelled, intensely brushed	iDESIGN PARQUET*	51780	90,33	43,26

<b>WP PLANK SWITCH</b>	WP Charisma Plank in all colours, gradings and surfaces	60019	126,69
------------------------	---	-------	--------

SURCHARGE EDGE PROFILES		EUR/lm
<b>EDGE PROFILE 40 SYLE</b>		+ 3,60
<b>EDGE PROFILE 58 SYLE</b>		+ 5,67
<b>EDGE PROFILE BLOCK SYLE</b> (riser is supplied loose)		+ 51,09

HP = Healthy-plank collection. All of the products in the collection are **Stock items**

MFP = Maintenance-free plank collection. All of the products in the collection are **Stock items**

All prices for WP Multi and Extras can be found on page 78



**Stock item delivery time:** promptly ex works (from 200 m<sup>2</sup> on request) | **iDesign Parkett delivery time (from 20 m<sup>2</sup> per item):** three to max. four weeks ex works (A flat LP surcharge of 400 EUR is billed under 20 m<sup>2</sup>.)  
All deliveries are based on the General Terms and Conditions of Business of Weitzer Parkett. All rights reserved for changes, composition and printing errors.

## WP CHARISMA PLANK

3-layer | Dimensions: 2245 x 193 x 14 mm | 1 Package = 2,60 m<sup>2</sup>

COLOUR RANGE NATURE				ITEM NO.	EUR/m <sup>2</sup>	EDGE PROFILE 40 FOR STEPS EUR/m Item No. 29889
	<b>OAK MANDEL</b>					
	Pvf rustic (essence)	bevelled, scraped	iDESIGN PARQUET*	50104	93,42	43,88
<b>OAK</b>						
	PA+ calm (select)		STOCK ITEM	18254	86,11	39,24
	PA+ calm (select)	bevelled, brushed	STOCK ITEM	20930	90,74	40,27
	Pvf calm (select)	bevelled	STOCK ITEM	29276	90,23	40,07
	Pvf calm (select)	bevelled, brushed	STOCK ITEM	29277	92,80	40,69
	Pvf calm (select)	bevelled, deep brushed	iDESIGN PARQUET*	29278	101,04	42,54
	Pvf calm (select)	bevelled, scraped	iDESIGN PARQUET*	51958	114,43	45,53
	PA+ lively (accent)		STOCK ITEM	60138	70,04	35,64
	PA+ lively (accent)	bevelled, brushed	STOCK ITEM	60135	74,68	36,67
	Pvf lively (accent)	bevelled	STOCK ITEM	60125	74,16	36,56
	Pvf lively (accent)	bevelled, brushed	STOCK ITEM	60136	76,74	37,08
	Pvf lively (accent)	bevelled, deep brushed	iDESIGN PARQUET*	60121	84,98	38,93
	Pvf lively (accent)	bevelled, scraped	iDESIGN PARQUET*	60126	98,37	41,92
	PA+ rustic (essence)	bevelled, brushed	STOCK ITEM	20931	64,07	34,30
	Pvf rustic (essence)	bevelled	iDESIGN PARQUET*	29168	69,73	35,54
	Pvf rustic (essence)	bevelled, brushed	STOCK ITEM	29169	66,13	34,71
	Pvf rustic (essence)	bevelled, deep brushed	iDESIGN PARQUET*	42097	74,37	36,56
	Pvf rustic (essence)	bevelled, intensely brushed	COLLECTION HP	50059	78,49	37,49
	Pvf rustic (essence)	bevelled, scraped	COLLECTION HP	49436	81,58	38,21
<b>OAK LIGHT</b>						
	PA+ rustic (essence)	bevelled, brushed	STOCK ITEM	60456	64,07	34,30
	Pvf rustic (essence)	bevelled, brushed	STOCK ITEM	60454	66,13	34,71
<b>WP PLANK SWITCH</b>	WP Charisma Plank in all colours, gradings and surfaces			60019	126,69	
<b>SURCHARGE EDGE PROFILES</b>						EUR/m
<b>EDGE PROFILE 40 SYLE</b>						+ 3,60
<b>EDGE PROFILE 58 SYLE</b>						+ 5,67
<b>EDGE PROFILE BLOCK SYLE</b> (riser is supplied loose)						+ 51,09

HP = Healthy-plank collection. All of the products in the collection are **Stock items**MFP = Maintenance-free plank collection. All of the products in the collection are **Stock items**

All prices for WP Multi and Extras can be found on page 78



**Stock item delivery time:** promptly ex works (from 200 m<sup>2</sup> on request) | **iDesign Parkett delivery time (from 20 m<sup>2</sup> per item):** three to max. four weeks ex works (A flat LP surcharge of 400 EUR is billed under 20 m<sup>2</sup>). All deliveries are based on the General Terms and Conditions of Business of Weitzer Parkett. All rights reserved for changes, composition and printing errors.

## WP CHARISMA PLANK

3-layer | Dimensions: 2245 x 193 x 14 mm | 1 Package = 2,60 m<sup>2</sup>



COLOUR RANGE NATURE	OAK PURE		ITEM NO.	EUR/m <sup>2</sup>	EDGE PROFILE 40 FOR STEPS EUR/lm Item No. 29889
---------------------	----------	--	----------	--------------------	---

	PVf	calm (select)	bevelled	iDESIGN PARQUET*	53990	102,07	45,84
	PVf	calm (select)	bevelled, brushed	iDESIGN PARQUET*	52057	104,65	46,45
	PVf	calm (select)	bevelled, deep brushed	iDESIGN PARQUET*	52244	106,71	46,87
	PVf	calm (select)	bevelled, scraped	iDESIGN PARQUET*	52156	120,10	49,85
	PA+	lively (accent)	bevelled, brushed	STOCK ITEM	62193	78,80	40,69
	PVf	lively (accent)	bevelled	iDESIGN PARQUET*	50658	86,01	42,23
	PVf	lively (accent)	bevelled, brushed	COLLECTION HP	52063	82,40	41,51
	PVf	lively (accent)	bevelled, deep brushed	iDESIGN PARQUET*	52245	90,64	43,26
	PVf	lively (accent)	bevelled, scraped	iDESIGN PARQUET*	52157	104,03	46,25
	PVf	rustic (essence)	bevelled	iDESIGN PARQUET*	50660	75,40	39,86
	PVf	rustic (essence)	bevelled, brushed	iDESIGN PARQUET*	52069	77,97	40,48
	PVf	rustic (essence)	bevelled, deep brushed	iDESIGN PARQUET*	52249	80,03	40,89
	PVf	rustic (essence)	bevelled, intensely brushed	iDESIGN PARQUET*	52120	90,33	43,26
	PVf	rustic (essence)	bevelled, scraped	iDESIGN PARQUET*	52159	93,42	43,88

COLOUR RANGE STONE	OAK AUSTER		ITEM NO.	EUR/m <sup>2</sup>	EDGE PROFILE 40 FOR STEPS EUR/lm Item No. 29889
--------------------	------------	--	----------	--------------------	---

	PVf	calm (select)	bevelled	iDESIGN PARQUET*	29273	102,07	45,84
	PVf	calm (select)	bevelled, brushed	iDESIGN PARQUET*	29272	104,65	46,45
	PVf	calm (select)	bevelled, deep brushed	iDESIGN PARQUET*	43713	106,71	46,87
	PVf	calm (select)	bevelled, scraped	iDESIGN PARQUET*	52351	120,10	49,85
	PVf	lively (accent)	bevelled	iDESIGN PARQUET*	29153	86,01	42,23
	PVf	lively (accent)	bevelled, brushed	iDESIGN PARQUET*	29154	88,58	42,85
	PVf	lively (accent)	bevelled, deep brushed	iDESIGN PARQUET*	43717	90,64	43,26
	PVf	lively (accent)	bevelled, scraped	iDESIGN PARQUET*	52352	104,03	46,25
	PA+	rustic (essence)	bevelled, brushed	STOCK ITEM	43804	68,19	38,32
	PVf	rustic (essence)	bevelled	iDESIGN PARQUET*	29164	75,40	39,86
	PVf	rustic (essence)	bevelled, brushed	STOCK ITEM	29165	71,79	39,14
	PVf	rustic (essence)	bevelled, deep brushed	iDESIGN PARQUET*	43726	80,03	40,89

<b>WP PLANK SWITCH</b>	WP Charisma Plank in all colours, gradings and surfaces	60019	126,69
------------------------	---	-------	--------

SURCHARGE EDGE PROFILES	EUR/lm
EDGE PROFILE 40 SYLE	+ 3,60
EDGE PROFILE 58 SYLE	+ 5,67
EDGE PROFILE BLOCK SYLE (riser is supplied loose)	+ 51,09

HP = Healthy-plank collection. All of the products in the collection are **Stock items**

MFP = Maintenance-free plank collection. All of the products in the collection are **Stock items**

All prices for WP Multi and Extras can be found on page 78



Stock item delivery time: promptly ex works (from 200 m<sup>2</sup> on request) | iDesign Parkett delivery time (from 20 m<sup>2</sup> per item): three to max. four weeks ex works (A flat LP surcharge of 400 EUR is billed under 20 m<sup>2</sup>.)

All deliveries are based on the General Terms and Conditions of Business of Weitzer Parkett. All rights reserved for changes, composition and printing errors.

## WP CHARISMA PLANK

3-layer | Dimensions: 2245 x 193 x 14 mm | 1 Package = 2,60 m<sup>2</sup>

COLOUR RANGE STONE		OAK AUSTER		ITEM NO.	EUR/m <sup>2</sup>	EDGE PROFILE 40 FOR STEPS EUR/lm Item No. 29889
	rustic (essence)	bevelled, intensely brushed	iDESIGN PARQUET*	52312	90,33	43,26
	rustic (essence)	bevelled, scraped	COLLECTION HP	49437	87,24	42,54

COLOUR RANGE STONE		OAK KASCHMIR		ITEM NO.	EUR/m <sup>2</sup>	EDGE PROFILE 40 FOR STEPS EUR/lm Item No. 29889
	calm (select)	bevelled	STOCK ITEM	25058	92,29	43,67
	calm (select)	bevelled	iDESIGN PARQUET*	29281	102,07	45,84
	calm (select)	bevelled, brushed	iDESIGN PARQUET*	29282	104,65	46,45
	calm (select)	bevelled, deep brushed	iDESIGN PARQUET*	43861	106,71	46,87
	calm (select)	bevelled, scraped	iDESIGN PARQUET*	52466	120,10	49,85
	lively (accent)	bevelled	STOCK ITEM	20932	76,22	40,07
	lively (accent)	bevelled, brushed	STOCK ITEM	43943	78,80	40,69
	lively (accent)	bevelled	iDESIGN PARQUET*	29159	86,01	42,23
	lively (accent)	bevelled, brushed	STOCK ITEM	29160	82,40	41,51
	lively (accent)	bevelled, deep brushed	iDESIGN PARQUET*	43866	90,64	43,26
	lively (accent)	bevelled, scraped	iDESIGN PARQUET*	52467	104,03	46,25
	rustic (essence)	bevelled, brushed	STOCK ITEM	43944	68,19	38,32
	rustic (essence)	bevelled	iDESIGN PARQUET*	29171	75,40	39,86
	rustic (essence)	bevelled, brushed	COLLECTION HP	29172	71,79	39,14
	rustic (essence)	bevelled, deep brushed	iDESIGN PARQUET*	43876	80,03	40,89
	rustic (essence)	bevelled, intensely brushed	iDESIGN PARQUET*	52431	90,33	43,26
	rustic (essence)	bevelled, scraped	iDESIGN PARQUET*	50096	93,42	43,88
	lively colourful (spectrum)	bevelled	STOCK ITEM	29310	74,68	39,76

COLOUR RANGE STONE		OAK ICE		ITEM NO.	EUR/m <sup>2</sup>	EDGE PROFILE 40 FOR STEPS EUR/lm Item No. 29889
	calm (select)	bevelled, deep brushed	iDESIGN PARQUET*	29280	110,83	47,79
	calm (select)	bevelled, scraped	iDESIGN PARQUET*	50662	124,22	50,78

<b>WP PLANK SWITCH</b>	WP Charisma Plank in all colours, gradings and surfaces	60019	126,69
------------------------	---	-------	--------

SURCHARGE EDGE PROFILES		EUR/lm
EDGE PROFILE 40 SYLE		+ 3,60
EDGE PROFILE 58 SYLE		+ 5,67
EDGE PROFILE BLOCK SYLE (riser is supplied loose)		+ 51,09

HP = Healthy-plank collection. All of the products in the collection are **Stock items**MFP = Maintenance-free plank collection. All of the products in the collection are **Stock items**

All prices for WP Multi and Extras can be found on page 78



**Stock item delivery time:** promptly ex works (from 200 m<sup>2</sup> on request) | **iDesign Parkett delivery time (from 20 m<sup>2</sup> per item):** three to max. four weeks ex works (A flat LP surcharge of 400 EUR is billed under 20 m<sup>2</sup>). All deliveries are based on the General Terms and Conditions of Business of Weitzer Parkett. All rights reserved for changes, composition and printing errors.



## WP CHARISMA PLANK

3-layer | Dimensions: 2245 x 193 x 14 mm | 1 Package = 2,60 m<sup>2</sup>



COLOUR RANGE STONE	OAK ICE		ITEM NO.	EUR/m <sup>2</sup>	EDGE PROFILE 40 FOR STEPS EUR/lm Item No. 29889
--------------------	---------	--	----------	--------------------	---

	PA+	lively (accent)	bevelled	<b>STOCK ITEM</b>	20933	<b>79,83</b>	40,89
	PVf	lively (accent)	bevelled, deep brushed	iDESIGN PARQUET*	43967	<b>94,76</b>	44,19
	PVf	lively (accent)	bevelled, scraped	iDESIGN PARQUET*	50663	<b>108,15</b>	47,17
	PVf	rustic (essence)	bevelled, deep brushed	<b>STOCK ITEM</b>	29170	<b>77,97</b>	40,48
	PVf	rustic (essence)	bevelled, intensely brushed	iDESIGN PARQUET*	53768	<b>94,45</b>	44,19
	PVf	rustic (essence)	bevelled, scraped	iDESIGN PARQUET*	50665	<b>97,54</b>	44,80

COLOUR RANGE STONE	OAK SAVANNE		ITEM NO.	EUR/m <sup>2</sup>	EDGE PROFILE 40 FOR STEPS EUR/lm Item No. 29889
--------------------	-------------	--	----------	--------------------	---

	PVf	calm (select)	bevelled	iDESIGN PARQUET*	50667	<b>102,07</b>	45,84
	PVf	calm (select)	bevelled, brushed	iDESIGN PARQUET*	52583	<b>104,65</b>	46,45
	PVf	calm (select)	bevelled, deep brushed	iDESIGN PARQUET*	52776	<b>106,71</b>	46,87
	PVf	calm (select)	bevelled, scraped	iDESIGN PARQUET*	52697	<b>120,10</b>	49,85
	PVf	lively (accent)	bevelled	iDESIGN PARQUET*	50668	<b>86,01</b>	42,23
	PVf	lively (accent)	bevelled, brushed	iDESIGN PARQUET*	52586	<b>88,58</b>	42,85
	PVf	lively (accent)	bevelled, deep brushed	iDESIGN PARQUET*	52777	<b>90,64</b>	43,26
	PVf	lively (accent)	bevelled, scraped	iDESIGN PARQUET*	52698	<b>104,03</b>	46,25
	PVf	rustic (essence)	bevelled	iDESIGN PARQUET*	50670	<b>75,40</b>	39,86
	PVf	rustic (essence)	bevelled, brushed	iDESIGN PARQUET*	52595	<b>77,97</b>	40,48
	PVf	rustic (essence)	bevelled, deep brushed	iDESIGN PARQUET*	52779	<b>80,03</b>	40,89
	PVf	rustic (essence)	bevelled, intensely brushed	<b>STOCK ITEM</b>	49433	<b>84,15</b>	41,82
	PVf	rustic (essence)	bevelled, scraped	iDESIGN PARQUET*	52700	<b>93,42</b>	43,88

COLOUR RANGE STONE	OAK POLAR		ITEM NO.	EUR/m <sup>2</sup>	EDGE PROFILE 40 FOR STEPS EUR/lm Item No. 29889
--------------------	-----------	--	----------	--------------------	---

	PVf	calm (select)	bevelled	iDESIGN PARQUET*	52855	<b>106,19</b>	46,76
	PVf	calm (select)	bevelled, brushed	iDESIGN PARQUET*	44050	<b>108,77</b>	47,28
	PVf	calm (select)	bevelled, deep brushed	iDESIGN PARQUET*	53025	<b>110,83</b>	47,79
	PVf	calm (select)	bevelled, scraped	iDESIGN PARQUET*	52945	<b>124,22</b>	50,78

<b>WP PLANK SWITCH</b>	WP Charisma Plank	in all colours, gradings and surfaces	60019	<b>126,69</b>	
------------------------	-------------------	---------------------------------------	-------	---------------	--

SURCHARGE EDGE PROFILES				EUR/lm
<b>EDGE PROFILE 40 SYLE</b>				+ 3,60
<b>EDGE PROFILE 58 SYLE</b>				+ 5,67
<b>EDGE PROFILE BLOCK SYLE</b> (riser is supplied loose)				+ 51,09

MFP = Maintenance-free plank collection. All of the products in the collection are **Stock items**

All prices for WP Multi and Extras can be found on page 78



Stock item delivery time: promptly ex works (from 200 m<sup>2</sup> on request) | iDesign Parkett delivery time (from 20 m<sup>2</sup> per item): three to max. four weeks ex works (A flat LP surcharge of 400 EUR is billed under 20 m<sup>2</sup>.)  
All deliveries are based on the General Terms and Conditions of Business of Weitzer Parkett. All rights reserved for changes, composition and printing errors.

## WP CHARISMA PLANK

3-layer | Dimensions: 2245 x 193 x 14 mm | 1 Package = 2,60 m<sup>2</sup>

COLOUR RANGE STONE		OAK POLAR		ITEM NO.	EUR/m <sup>2</sup>	EDGE PROFILE 40 FOR STEPS EUR/m Item No. 29889
	Pvf lively (accent)	bevelled	iDESIGN PARQUET*	52857	90,13	43,16
	Pvf lively (accent)	bevelled, brushed	STOCK ITEM	29163	86,52	42,33
	Pvf lively (accent)	bevelled, deep brushed	iDESIGN PARQUET*	53026	94,76	44,19
	Pvf lively (accent)	bevelled, scraped	iDESIGN PARQUET*	52946	108,15	47,17
	Pvf rustic (essence)	bevelled	iDESIGN PARQUET*	52861	79,52	40,79
	Pvf rustic (essence)	bevelled, brushed	iDESIGN PARQUET*	44058	82,09	41,41
	Pvf rustic (essence)	bevelled, deep brushed	iDESIGN PARQUET*	53028	84,15	41,82
	Pvf rustic (essence)	bevelled, intensely brushed	iDESIGN PARQUET*	49435	94,45	44,19
	Pvf rustic (essence)	bevelled, scraped	iDESIGN PARQUET*	52948	97,54	44,80
	PA+ lively colourful (spectrum)	bevelled	STOCK ITEM	49324	71,07	38,93
COLOUR RANGE STONE		OAK TRÜFFELGRAU		ITEM NO.	EUR/m <sup>2</sup>	EDGE PROFILE 40 FOR STEPS EUR/m Item No. 29889
	Pvf calm (select)	bevelled	COLLECTION HP	63841	100,01	45,42
	Pvf calm (select)	bevelled, brushed	iDESIGN PARQUET*	63842	108,77	47,28
	Pvf calm (select)	bevelled, deep brushed	iDESIGN PARQUET*	63844	110,83	47,79
	Pvf calm (select)	bevelled, scraped	iDESIGN PARQUET*	63843	124,22	50,78
	Pvf lively (accent)	bevelled	iDESIGN PARQUET*	63838	90,13	43,16
	Pvf lively (accent)	bevelled, brushed	iDESIGN PARQUET*	63837	92,70	43,77
	Pvf lively (accent)	bevelled, deep brushed	iDESIGN PARQUET*	63840	94,76	44,19
	Pvf lively (accent)	bevelled, scraped	iDESIGN PARQUET*	63839	108,15	47,17
	Pvf rustic (essence)	bevelled	iDESIGN PARQUET*	63847	79,52	40,79
	Pvf rustic (essence)	bevelled, brushed	iDESIGN PARQUET*	63849	82,09	41,41
	Pvf rustic (essence)	bevelled, deep brushed	iDESIGN PARQUET*	63851	84,15	41,82
	Pvf rustic (essence)	bevelled, intensely brushed	iDESIGN PARQUET*	63852	94,45	44,19
	Pvf rustic (essence)	bevelled, scraped	iDESIGN PARQUET*	63850	97,54	44,80
	PA+ lively colourful (spectrum)	bevelled	STOCK ITEM	28097	78,28	40,58
<b>WP PLANK SWITCH</b>				WP Charisma Plank in all colours, gradings and surfaces	60019	126,69
<b>SURCHARGE EDGE PROFILES</b>						EUR/m
<b>EDGE PROFILE 40 SYLE</b>						+ 3,60
<b>EDGE PROFILE 58 SYLE</b>						+ 5,67
<b>EDGE PROFILE BLOCK SYLE</b> (riser is supplied loose)						+ 51,09

HP = Healthy-plank collection. All of the products in the collection are **Stock items**

All prices for WP Multi and Extras can be found on page 78



**Stock item delivery time:** promptly ex works (from 200 m<sup>2</sup> on request) | **iDesign Parkett delivery time (from 20 m<sup>2</sup> per item):** three to max. four weeks ex works (A flat LP surcharge of 400 EUR is billed under 20 m<sup>2</sup>). All deliveries are based on the General Terms and Conditions of Business of Weitzer Parkett. All rights reserved for changes, composition and printing errors.

## WP CHARISMA PLANK

3-layer | Dimensions: 2245 x 193 x 14 mm | 1 Package = 2,60 m<sup>2</sup>



COLOUR RANGE	STONE				ITEM NO.	EUR/m <sup>2</sup>	EDGE PROFILE 40 FOR STEPS EUR/lm Item No. 29889
PvF	lively colourful (spectrum)	bevelled, deep brushed	STOCK ITEM		62266	83,43	41,72
					OAK COLORADO DIAMOND ICE		
PvF	calm (select)	bevelled	iDESIGN PARQUET*	53120	102,07	45,84	
		bevelled, brushed	iDESIGN PARQUET*	44142	104,65	46,45	
		bevelled, deep brushed	iDESIGN PARQUET*	53288	106,71	46,87	
		bevelled, scraped	iDESIGN PARQUET*	53210	120,10	49,85	
	lively (accent)	bevelled	iDESIGN PARQUET*	53122	86,01	42,23	
		bevelled, brushed	iDESIGN PARQUET*	44144	88,58	42,85	
		bevelled, deep brushed	iDESIGN PARQUET*	53292	90,64	43,26	
		bevelled, scraped	iDESIGN PARQUET*	53211	104,03	46,25	
	rustic (essence)	bevelled	iDESIGN PARQUET*	53129	75,40	39,86	
		bevelled, brushed	iDESIGN PARQUET*	44147	77,97	40,48	
		bevelled, deep brushed	iDESIGN PARQUET*	53294	80,03	40,89	
		bevelled, intensely brushed	iDESIGN PARQUET*	53173	90,33	43,26	
bevelled, scraped		iDESIGN PARQUET*	49520	93,42	43,88		
PA+	lively colourful (spectrum)	bevelled	STOCK ITEM	53061	71,07	38,93	
PvF	rustic colourful (original)	bevelled, brushed	STOCK ITEM		29324	118,55	51,09
					SWISS STONE PINE EDELWEISS		
PA+	lively colourful (natural)	bevelled, brushed	STOCK ITEM		20935	65,20	34,71
					ASH		

<b>WP PLANK SWITCH</b>	WP Charisma Plank in all colours, gradings and surfaces	60019	126,69	
<b>SURCHARGE EDGE PROFILES</b>				EUR/lm
<b>EDGE PROFILE 40 SYLE</b>				+ 3,60
<b>EDGE PROFILE 58 SYLE</b>				+ 5,67
<b>EDGE PROFILE BLOCK SYLE</b> (riser is supplied loose)				+ 51,09

MFP = Maintenance-free plank collection. All of the products in the collection are **Stock items**

All prices for WP Multi and Extras can be found on page 78

**Stock item delivery time:** promptly ex works (from 200 m<sup>2</sup> on request) | **iDesign Parkett delivery time (from 20 m<sup>2</sup> per item):** three to max. four weeks ex works (A flat LP surcharge of 400 EUR is billed under 20 m<sup>2</sup>.)  
All deliveries are based on the General Terms and Conditions of Business of Weitzer Parkett. All rights reserved for changes, composition and printing errors.

**WP CHARISMA PLANK**  
**WOODEN STAIRS WP MULTI**Prices apply for all colours, surface finishes,  
grades, and additional treatments.

PROFILE 40	SPECIES	TREAD PANEL without carrier panel   Item No.: 29874		RISER Item No.: 54271	WALL COVERING Item No.: 54310
		EURO/ STEPS/linear meters straight	EURO/ STEPS/linear meters L- and U-SHAPED	EURO/ STEPS/linear meters	EURO/ linear meters
	Fumed Oak	94,55	111,14	48,00	75,09
	Oak Coffee	94,55	111,14	48,00	75,09
	Oak	80,13	94,14	40,79	63,76
	Ash	79,00	92,80	40,07	63,14
	Stone pine	95,79	112,58	48,51	76,22
	White (RAL 9010)	-	-	21,22	-
SURCHARGE					
PROFILE 40 STYLE		14,21	14,21	-	-
PROFILE 58 STYLE		16,27	16,27	-	-
PROFILE BLOCK STYLE		51,09	51,09	Riser is included in the price and is supplied loose.	-
Continuous top layer, no header joint Up to product length		+ 30 %	+ 30 %	Riser panel will be delivered as one continuous piece of plank	+ 30 %
Carrier panel 6 mm, 17 mm or 27 mm		15,04	15,04	9,17	9,17
Customization Only possible with digital measuring system or stencils/moulds		14,63	17,41	15,96	Is customized
Riser pre-drilled, including screws Minimum thickness 19 mm		-	-	13,70	-
SURCHARGE		TREAD PANEL without carrier panel   Item No.: 48748		RISER Item No.: 54335	WALL COVERING Item No.: 54311
iDESIGN PARKETT® all species		6,18	6,18	6,18	6,18

Orders for prefab tread panels possible using the WP Multi measurement sheet.  
Templates for download from Weitzer Parkett Partner Portal.

WOODEN STAIRS WP MULTI   EXTRAS					
Multi Front Edge (FE) PROFILE 40, 40 STYLE, BLOCK STYLE Item No.: 40272   right/left   available on request without a tongue	350 mm   EURO/pc.	10,51	600 mm   EURO/pc.	13,49	
Multi Front Edge (FE) PROFILE 58 STYLE Item No.: 40272   right/left   available on request without a tongue	350 mm   EURO/pc.	11,54	600 mm   EURO/pc.	14,52	
Multi Wall Cover Moulding (WCM) PROFILE 40, 40 STYLE, 58 STYLE BLOCK STYLE Item No.: 40281   right/left, straight/L- and U-shaped	350 mm   EURO/pc.	10,51	650 mm   EURO/pc.	19,47	
Multi Front Edge - Riser (FER) PROFILE 40/58 STYLE for riser	white   EURO/lm Item No.: 40463	6,90	Species   EURO/lm Item No.: 40279	12,77	
Multi Landing Wall Cover Moulding Item No.: 40627	40 x 14 mm   EURO/lm			15,35	
Multi Front Edge (FE) execute for treads including material	Tread Panel + wall covering EURO/pc.			23,18	
Edge Profile for Stairs 40 (LEP) Item No.: 54295 Dimensions: 40 mm x 14 mm   curvature/radius: 3 mm Fixed length: 2500 mm   including false tongue	Colour range LAVA/TERRA EURO/lm	20,19	remaining colour scheme EURO/lm	16,07	

Further extras and detailed descriptions from page 141!

WP Multi wooden stairs delivery time **Stock items:** 12 working days from order confirmation ex works. Stair edge profile delivery time **Stock items:** 7 working days from order confirmation ex works.

WP Multi iDESIGN PARKETT® wooden staircase delivery time: 5-8 working weeks from order confirmation ex works. iDESIGN PARKETT® edge profile for stairs delivery time: 5-8 working weeks from order confirmation ex works.





## WP PERFORMANCE PLANK

2-layer | Dimensions: 1800 x 175 x 9,3 mm | 1 Package = 2,52 m<sup>2</sup>

COLOUR RANGE NATURE		OAK			ITEM NO.	EUR/m <sup>2</sup>	EDGE PROFILE 40 FOR STEPS EUR/m Item No. 57026
	PA+ calm (select)	bevelled, brushed	COLLECTION PP	56703	67,57	33,06	
	PA+ lively (accent)	bevelled, brushed	COLLECTION PP	60221	55,93	30,69	
	PVf lively (accent)	bevelled, deep brushed	COLLECTION PP	60222	60,05	31,52	
	PVf lively (accent)	bevelled, scraped	COLLECTION PP	60223	73,44	34,20	
COLOUR RANGE STONE		OAK SAVANNE			ITEM NO.	EUR/m <sup>2</sup>	EDGE PROFILE 40 FOR STEPS EUR/m Item No. 57026
	PA+ lively colourful (original)	bevelled, brushed	COLLECTION PP	56705	56,34	33,89	
	PVf lively colourful (original)	bevelled, deep brushed	COLLECTION PP	56706	62,01	35,02	

PP = Performance-plank collection. All of the products in the collection are **Stock items**

SURCHARGE EDGE PROFILES	EUR/m
EDGE PROFILE 40 SYLE	+ 3,60
EDGE PROFILE 58 SYLE	+ 5,67
EDGE PROFILE BLOCK SYLE (riser is supplied loose)	+ 58,50

All prices for WP Multi and Extras can be found on page 81



**Stock item delivery time:** promptly ex works (from 200 m<sup>2</sup> on request) | **iDesign Parkett delivery time (from 20 m<sup>2</sup> per item):** three to max. four weeks ex works (A flat LP surcharge of 400 EUR is billed under 20 m<sup>2</sup>.)  
All deliveries are based on the General Terms and Conditions of Business of Weitzer Parkett. All rights reserved for changes, composition and printing errors.



## WP PERFORMANCE PLANK WOODEN STAIRS WP MULTI

Prices apply for all colours, surface finishes, grades, and additional treatments.

PROFILE 40	SPECIES	TREAD PANEL including carrier panel   Item No.: 56920		RISER Item No.: 56921	WALL COVERING Item No.: 56922
		EURO/ STEPS/linear meters straight	EURO/ STEPS/linear meters L- and U-SHAPED	EURO/ STEPS/linear meters	EURO/ linear meters
	Oak	<b>95,07</b>	<b>111,76</b>	<b>48,20</b>	<b>76,12</b>
	White (RAL 9010)	-	-	<b>21,22</b>	-
SURCHARGE					
PROFILE 40 STYLE		<b>15,24</b>	<b>15,24</b>	-	-
PROFILE 58 STYLE		<b>17,30</b>	<b>17,30</b>	-	-
PROFILE BLOCK STYLE		<b>58,50</b>	<b>58,50</b>	Riser is included in the price and is supplied loose.	-
Continuous top layer, no header joint Up to product length		<b>+ 30 %</b>	<b>+ 30 %</b>	Riser panel will be delivered as one continuous piece of plank	<b>+ 30 %</b>
Customization Only possible with digital measuring system or stencils/moulds		<b>14,63</b>	<b>17,41</b>	<b>15,96</b>	Is customized
Riser pre-drilled, including screws Minimum thickness 19 mm		-	-	<b>13,70</b>	-

Orders for prefab tread panels possible using the WP Multi measurement sheet.  
Templates for download from Weitzer Parkett Partner Portal.

WOODEN STAIRS WP MULTI   EXTRAS					
<b>Multi Front Edge (FE)</b> <b>PROFILE 40, 40 STYLE, BLOCK STYLE</b> Item No.: 40272   right/left   available on request without a tongue	350 mm   EURO/pc.	<b>10,51</b>	600 mm   EURO/pc.	<b>13,49</b>	
<b>Multi Front Edge (FE)</b> <b>PROFILE 58 STYLE</b> Item No.: 40272   right/left   available on request without a tongue	350 mm   EURO/pc.	<b>11,54</b>	600 mm   EURO/pc.	<b>14,52</b>	
<b>Multi Wall Cover Moulding (WCM)</b> <b>PROFILE 40, 40 STYLE, 58 STYLE BLOCK STYLE</b> Item No.: 40281   right/left, straight/L- and U-shaped	350 mm   EURO/pc.	<b>10,51</b>	650 mm   EURO/pc.	<b>19,47</b>	
<b>Multi Front Edge - Riser (FER)</b> <b>PROFILE 40/58 STYLE</b> for riser	white   EURO/lm Item No.: 40463	<b>6,90</b>	Species   EURO/lm Item No.: 40279	<b>12,77</b>	
<b>Multi Landing Wall Cover Moulding</b> Item No.: 40627	40 x 14 mm   EURO/lm		<b>15,35</b>		
<b>Multi Front Edge (FE) execute</b> for treads including material	Tread Panel + wall covering EURO/pc.		<b>23,18</b>		
<b>Edge Profile for Stairs 40 (LEP)</b> Item No.: 54295 Dimensions: 40 mm x 14 mm   curvature/radius: 3 mm Fixed length: 2500 mm	Colour range <b>LAVA/TERRA</b> EURO/lm	<b>20,19</b>	remaining colour scheme EURO/lm	<b>16,07</b>	

Further extras and detailed descriptions from page 141!

## WP COMFORT PLANK

3-layer | Dimensions: 1800 x 175 x 11 mm | 1 Package = 2,52 m<sup>2</sup>

COLOUR RANGE				ITEM NO.	EUR/m <sup>2</sup>	EDGE PROFILE 40 FOR STEPS EUR/lm Item No. 49073
COLOUR RANGE TERRA		<b>OAK HAVANA</b>				
	PA+ rustic colourful (original)	bevelled, brushed	COLLECTION COP	48383	53,97	33,99
COLOUR RANGE MATURE		<b>OAK</b>				
	PA+ calm (select)	bevelled, brushed	STOCK ITEM	59481	72,82	34,71
	PA+ rustic (original*)	bevelled, brushed	COLLECTION COP	48375	52,74	30,69
	PVf rustic (original*)	bevelled, brushed	STOCK ITEM	57034	54,80	31,11
COLOUR RANGE MATURE		<b>OAK PURE</b>				
	PA+ rustic colourful (original)	bevelled, brushed	COLLECTION COP	62192	53,97	33,99
	PVf rustic colourful (original)	bevelled, brushed	STOCK ITEM	62222	57,58	34,71
COLOUR RANGE STONE		<b>OAK AUSTER</b>				
	PA+ rustic colourful (original)	bevelled, brushed	COLLECTION COP	48377	53,97	33,99
COLOUR RANGE STONE		<b>OAK KASCHMIR</b>				
	PA+ calm (select)	bevelled, brushed	STOCK ITEM	59482	76,94	38,63
	PA+ rustic colourful (original)	bevelled, brushed	COLLECTION COP	48381	53,97	33,99
	PVf rustic colourful (original)	bevelled, brushed	STOCK ITEM	57087	57,58	34,71

<b>WP PLANK SWITCH</b>	WP Comfort Plank in all colours, gradings and surfaces	60036	113,20
------------------------	--	-------	--------

SURCHARGE EDGE PROFILES	EUR/lm
EDGE PROFILE 40 SYLE	+ 3,60
EDGE PROFILE 58 SYLE	+ 5,67
EDGE PROFILE BLOCK SYLE (riser is supplied loose)	+ 47,07

All prices for WP Multi and Extras can be found on page 84

\*no sapwood



**Stock item delivery time:** promptly ex works (from 200 m<sup>2</sup> on request) | **iDesign Parkett delivery time (from 20 m<sup>2</sup> per item):** three to max. four weeks ex works (A flat LP surcharge of 400 EUR is billed under 20 m<sup>2</sup>). All deliveries are based on the General Terms and Conditions of Business of Weitzer Parkett. All rights reserved for changes, composition and printing errors.

## WP COMFORT PLANK

3-layer | Dimensions: 1800 x 175 x 11 mm | 1 Package = 2,52 m<sup>2</sup>



COLOUR RANGE	STONE				ITEM NO.	EUR/m <sup>2</sup>	EDGE PROFILE 40 FOR STEPS EUR/m Item No. 49073
		<b>OAK SAVANNE</b>					
	PvF	rustic colourful (original)	bevelled, brushed	<b>STOCK ITEM</b>	57035	<b>57,58</b>	34,71
		<b>ASH POLAR</b>					
	PA+	rustic colourful (vibrant)	bevelled, brushed	<b>STOCK ITEM</b>	48369	<b>50,99</b>	33,68
		<b>OAK COLORADO DIAMOND ICE</b>					
	PA+	rustic colourful (original)	bevelled, brushed	<b>STOCK ITEM</b>	62351	<b>61,18</b>	35,54

<b>WP PLANK SWITCH</b>	WP Comfort Plank in all colours, gradings and surfaces	60036	<b>113,20</b>
------------------------	--	-------	---------------

SURCHARGE EDGE PROFILES		EUR/m
<b>EDGE PROFILE 40 SYLE</b>		+ 3,60
<b>EDGE PROFILE 58 SYLE</b>		+ 5,67
<b>EDGE PROFILE BLOCK SYLE</b> (riser is supplied loose)		+ 47,07

All prices for WP Multi and Extras can be found on page 84

**WP COMFORT PLANK**  
**WOODEN STAIRS WP MULTI**Prices apply for all colours, surface finishes,  
grades, and additional treatments.

PROFILE 40	SPECIES	TREAD PANEL without Carrier panel   Item No.: 49067		RISER Item No.: 54284	WALL COVERING Item No.: 54345
		EURO/ STEPS/linear meters straight	EURO/ STEPS/linear meters L- and U-SHAPED	EURO/ STEPS/linear meters	EURO/ linear meters
	Oak	<b>71,79</b>	<b>84,36</b>	<b>36,77</b>	<b>57,58</b>
	Ash	<b>70,97</b>	<b>83,43</b>	<b>35,95</b>	<b>56,75</b>
	White (RAL 9010)	-	-	<b>21,22</b>	-
<b>SURCHARGE</b>					
<b>PROFILE 40 STYLE</b>		<b>10,61</b>	<b>10,61</b>	-	-
<b>PROFILE 58 STYLE</b>		<b>12,67</b>	<b>12,67</b>	-	-
<b>PROFILE BLOCK STYLE</b>		<b>47,07</b>	<b>47,07</b>	Riser is included in the price and is supplied loose.	-
<b>Continuous top layer, no header joint</b> Up to product length		<b>+ 30 %</b>	<b>+ 30 %</b>	Riser panel will be delivered as one continuous piece of plank	<b>+ 30 %</b>
<b>Carrier panel</b> 6 mm, 17 mm or 27 mm		<b>15,04</b>	<b>15,04</b>	<b>9,17</b>	<b>9,17</b>
<b>Customization</b> Only possible with digital measuring system or stencils/moulds		<b>14,63</b>	<b>17,41</b>	<b>15,96</b>	Is customized
<b>Riser pre-drilled, including screws</b> Minimum thickness 19 mm		-	-	<b>13,70</b>	-

Orders for prefab tread panels possible using the WP Multi measurement sheet.  
Templates for download from Weitzer Parkett Partner Portal.

<b>WOODEN STAIRS WP MULTI   EXTRAS</b>					
<b>Multi Front Edge (FE)</b> <b>PROFILE 40, 40 STYLE, BLOCK STYLE</b> Item No.: 40272   right/left   available on request without a tongue	350 mm   EURO/pc.	<b>10,51</b>	600 mm   EURO/pc.	<b>13,49</b>	
<b>Multi Front Edge (FE)</b> <b>PROFILE 58 STYLE</b> Item No.: 40272   right/left   available on request without a tongue	350 mm   EURO/pc.	<b>11,54</b>	600 mm   EURO/pc.	<b>14,52</b>	
<b>Multi Wall Cover Moulding (WCM)</b> <b>PROFILE 40, 40 STYLE, 58 STYLE BLOCK STYLE</b> Item No.: 40281   right/left, straight/L- and U-shaped	350 mm   EURO/pc.	<b>10,51</b>	650 mm   EURO/pc.	<b>19,47</b>	
<b>Multi Front Edge - Riser (FER)</b> <b>PROFILE 40/58 STYLE</b> for riser	white   EURO/lm Item No.: 40463	<b>6,90</b>	Species   EURO/lm Item No.: 40279	<b>12,77</b>	
<b>Multi Landing Wall Cover Moulding</b> Item No.: 40627	40 x 14 mm   EURO/lm		<b>15,35</b>		
<b>Multi Front Edge (FE) execute</b> for treads including material	Tread Panel + wall covering EURO/pc.		<b>23,18</b>		
<b>Edge Profile for Stairs 40 (LEP)</b> Item No.: 54295 Dimensions: 40 mm x 14 mm   curvature/radius: 3 mm Fixed length: 2500 mm   including false tongue	Colour range <b>LAVA/TERRA</b> EURO/lm	<b>20,19</b>	remaining colour scheme EURO/lm	<b>16,07</b>	

Further extras and detailed descriptions from page 141!

WP Multi wooden stairs delivery time **Stock items**: 12 working days from order confirmation ex works. Stair edge profile delivery time **Stock items**: 7 working days from order confirmation ex works.WP Multi **iDESIGN PARKETT®** wooden staircase delivery time: 5-8 working weeks from order confirmation ex works. **iDESIGN PARKETT®** edge profile for stairs delivery time: 5-8 working weeks from order confirmation ex works.





## WP QUADRA 1800

3-layer | Dimensions: 1800 x 175 x 14 mm | 1 Package = 1,89 m<sup>2</sup>

COLOUR RANGE				ITEM NO.	EUR/m <sup>2</sup>	EDGE PROFILE 40 FOR STEPS EUR/lm Item No. 62007	
COLOUR RANGE LAVA	<b>FUMED OAK</b>						
	PA+ lively (original*)	bevelled, brushed	STOCK ITEM	63620	90,54	43,16	
	PVf lively (original*)	bevelled, brushed	STOCK ITEM	63621	92,60	43,57	
COLOUR RANGE TERRA	<b>NUT STEAMED</b>						
	PA+ lively colourful (original)	bevelled	STOCK ITEM	63725	120,41	50,57	
	PVf lively colourful (original)	bevelled	STOCK ITEM	63724	122,47	50,98	
COLOUR RANGE TERRA	<b>OAK KROKANT</b>						
	PVf calm (select)	bevelled	iDESIGN PARQUET®	61904	92,08	43,16	
	PVf calm (select)	bevelled, brushed	iDESIGN PARQUET®	61905	94,66	43,67	
	PVf calm (select)	bevelled, deep brushed	iDESIGN PARQUET®	61902	96,72	44,08	
	PVf calm (select)	bevelled, scraped	iDESIGN PARQUET®	61903	110,11	46,76	
	PVf lively (accent)	bevelled	iDESIGN PARQUET®	61912	77,87	40,27	
	PVf lively (accent)	bevelled, brushed	iDESIGN PARQUET®	61913	80,44	40,79	
	PVf lively (accent)	bevelled, deep brushed	iDESIGN PARQUET®	61910	82,50	41,20	
	PVf lively (accent)	bevelled, scraped	iDESIGN PARQUET®	61911	95,89	43,98	
	PVf rustic (essence)	bevelled	iDESIGN PARQUET®	61895	69,53	38,63	
	PVf rustic (essence)	bevelled, brushed	iDESIGN PARQUET®	61896	72,10	39,14	
	PVf rustic (essence)	bevelled, deep brushed	iDESIGN PARQUET®	61893	74,16	39,55	
	PVf rustic (essence)	bevelled, intensely brushed	iDESIGN PARQUET®	61892	84,46	41,61	
	PVf rustic (essence)	bevelled, scraped	iDESIGN PARQUET®	61894	87,55	42,23	
	COLOUR RANGE MATURE	<b>OAK MANDEL</b>					
		PVf calm (select)	bevelled	iDESIGN PARQUET®	61874	92,08	43,16
	PVf calm (select)	bevelled, brushed	iDESIGN PARQUET®	61875	94,66	43,67	

\*no sapwood

## SURCHARGE EDGE PROFILES

EUR/lm

EDGE PROFILE 40 SYLE	+ 3,60
EDGE PROFILE 58 SYLE	+ 5,67
EDGE PROFILE BLOCK SYLE (riser is supplied loose)	+ 55,72

All prices for WP Multi and Extras can be found on page 93



**Stock item delivery time:** promptly ex works (from 200 m<sup>2</sup> on request) | **iDesign Parkett delivery time (from 20 m<sup>2</sup> per item):** three to max. four weeks ex works (A flat LP surcharge of 400 EUR is billed under 20 m<sup>2</sup>). All deliveries are based on the General Terms and Conditions of Business of Weitzer Parkett. All rights reserved for changes, composition and printing errors.

## WP QUADRA 1800

3-layer | Dimensions: 1800 x 175 x 14 mm | 1 Package = 1,89 m<sup>2</sup>



COLOUR RANGE NATURE		OAK MANDEL			ITEM NO.	EUR/m <sup>2</sup>	EDGE PROFILE 40 FOR STEPS EUR/m Item No. 62007
	PVf	calm (select)	bevelled, deep brushed	iDESIGN PARQUET*	61872	<b>96,72</b>	44,08
	PVf	calm (select)	bevelled, scraped	iDESIGN PARQUET*	61873	<b>110,11</b>	46,76
	PVf	lively (accent)	bevelled	iDESIGN PARQUET*	61883	<b>77,87</b>	40,27
	PVf	lively (accent)	bevelled, brushed	iDESIGN PARQUET*	61885	<b>80,44</b>	40,79
	PVf	lively (accent)	bevelled, deep brushed	iDESIGN PARQUET*	61881	<b>82,50</b>	41,20
	PVf	lively (accent)	bevelled, scraped	iDESIGN PARQUET*	61882	<b>95,89</b>	43,98
	PVf	rustic (essence)	bevelled	iDESIGN PARQUET*	61864	<b>69,53</b>	38,63
	PVf	rustic (essence)	bevelled, brushed	iDESIGN PARQUET*	61865	<b>72,10</b>	39,14
	PVf	rustic (essence)	bevelled, deep brushed	iDESIGN PARQUET*	61862	<b>74,16</b>	39,55
	PVf	rustic (essence)	bevelled, intensely brushed	iDESIGN PARQUET*	61861	<b>84,46</b>	41,61
	PVf	rustic (essence)	bevelled, scraped	iDESIGN PARQUET*	61863	<b>87,55</b>	42,23

COLOUR RANGE NATURE		OAK			ITEM NO.	EUR/m <sup>2</sup>	EDGE PROFILE 40 FOR STEPS EUR/m Item No. 62007
	PA+	calm (select)	bevelled, brushed	<b>STOCK ITEM</b>	61778	<b>80,75</b>	37,80
	PVf	calm (select)	bevelled	iDESIGN PARQUET*	61780	<b>86,42</b>	38,93
	PVf	calm (select)	bevelled, brushed	<b>STOCK ITEM</b>	61779	<b>82,81</b>	38,21
	PVf	calm (select)	bevelled, deep brushed	iDESIGN PARQUET*	61784	<b>91,05</b>	39,86
	PVf	calm (select)	bevelled, scraped	iDESIGN PARQUET*	61783	<b>104,44</b>	42,54
	PA+	lively (accent)	bevelled, brushed	<b>STOCK ITEM</b>	61766	<b>66,54</b>	34,92
	PVf	lively (accent)	bevelled	iDESIGN PARQUET*	61772	<b>72,20</b>	36,05
	PVf	lively (accent)	bevelled, brushed	<b>STOCK ITEM</b>	61771	<b>68,60</b>	35,33
	PVf	lively (accent)	bevelled, deep brushed	iDESIGN PARQUET*	61777	<b>76,84</b>	36,98
	PVf	lively (accent)	bevelled, scraped	iDESIGN PARQUET*	61773	<b>90,23</b>	39,76
	PA+	rustic (essence)	bevelled, brushed	<b>STOCK ITEM</b>	61785	<b>58,20</b>	33,27
	PVf	rustic (essence)	bevelled	iDESIGN PARQUET*	61719	<b>63,86</b>	34,40
	PVf	rustic (essence)	bevelled, brushed	<b>STOCK ITEM</b>	61786	<b>60,26</b>	33,68
	PVf	rustic (essence)	bevelled, deep brushed	iDESIGN PARQUET*	61721	<b>68,50</b>	35,33
	PVf	rustic (essence)	bevelled, intensely brushed	iDESIGN PARQUET*	61722	<b>78,80</b>	37,39

SURCHARGE EDGE PROFILES		EUR/m
EDGE PROFILE 40 SYLE		+ 3,60
EDGE PROFILE 58 SYLE		+ 5,67
EDGE PROFILE BLOCK SYLE (riser is supplied loose)		+ 55,72

All prices for WP Multi and Extras can be found on page 93

## WP QUADRA 1800

3-layer | Dimensions: 1800 x 175 x 14 mm | 1 Package = 1,89 m<sup>2</sup>

COLOUR RANGE MATURE		OAK		ITEM NO.	EUR/m <sup>2</sup>	EDGE PROFILE 40 FOR STEPS EUR/lm Item No. 62007
	rustic (essence)	bevelled, scraped	iDESIGN PARQUET*	61720	81,89	38,01
COLOUR RANGE MATURE		OAK PURE		ITEM NO.	EUR/m <sup>2</sup>	EDGE PROFILE 40 FOR STEPS EUR/lm Item No. 62007
	calm (select)	bevelled	iDESIGN PARQUET*	61561	92,08	43,16
	calm (select)	bevelled, brushed	iDESIGN PARQUET*	61562	94,66	43,67
	calm (select)	bevelled, deep brushed	iDESIGN PARQUET*	61559	96,72	44,08
	calm (select)	bevelled, scraped	iDESIGN PARQUET*	61560	110,11	46,76
	lively (accent)	bevelled	STOCK ITEM	61802	68,08	38,32
	lively (accent)	bevelled	iDESIGN PARQUET*	61814	77,87	40,27
	lively (accent)	bevelled, brushed	iDESIGN PARQUET*	61815	80,44	40,79
	lively (accent)	bevelled, deep brushed	iDESIGN PARQUET*	61812	82,50	41,20
	lively (accent)	bevelled, scraped	iDESIGN PARQUET*	61813	95,89	43,98
	rustic (essence)	bevelled	STOCK ITEM	61831	59,74	36,67
	rustic (essence)	bevelled	iDESIGN PARQUET*	61552	69,53	38,63
	rustic (essence)	bevelled, brushed	iDESIGN PARQUET*	61553	72,10	39,14
	rustic (essence)	bevelled, deep brushed	iDESIGN PARQUET*	61550	74,16	39,55
	rustic (essence)	bevelled, intensely brushed	iDESIGN PARQUET*	61549	84,46	41,61
	rustic (essence)	bevelled, scraped	iDESIGN PARQUET*	61551	87,55	42,23
COLOUR RANGE STONE		OAK AUSTER		ITEM NO.	EUR/m <sup>2</sup>	EDGE PROFILE 40 FOR STEPS EUR/lm Item No. 62007
	calm (select)	bevelled	iDESIGN PARQUET*	61431	92,08	43,16
	calm (select)	bevelled, brushed	iDESIGN PARQUET*	61428	94,66	43,67
	calm (select)	bevelled, deep brushed	iDESIGN PARQUET*	61435	96,72	44,08
	calm (select)	bevelled, scraped	iDESIGN PARQUET*	61433	110,11	46,76
	lively (accent)	bevelled, brushed	STOCK ITEM	61375	70,66	38,83
	lively (accent)	bevelled	iDESIGN PARQUET*	61402	77,87	40,27
	lively (accent)	bevelled, brushed	iDESIGN PARQUET*	61376	80,44	40,79

## SURCHARGE EDGE PROFILES

EUR/lm

## EDGE PROFILE 40 SYLE

+ 3,60

## EDGE PROFILE 58 SYLE

+ 5,67

## EDGE PROFILE BLOCK SYLE (riser is supplied loose)

+ 55,72

All prices for WP Multi and Extras can be found on page 93



**Stock item delivery time:** promptly ex works (from 200 m<sup>2</sup> on request) | **iDesign Parkett delivery time (from 20 m<sup>2</sup> per item):** three to max. four weeks ex works (A flat LP surcharge of 400 EUR is billed under 20 m<sup>2</sup>). All deliveries are based on the General Terms and Conditions of Business of Weitzer Parkett. All rights reserved for changes, composition and printing errors.

## WP QUADRA 1800

3-layer | Dimensions: 1800 x 175 x 14 mm | 1 Package = 1,89 m<sup>2</sup>



COLOUR RANGE	STONE				ITEM NO.	EUR/m <sup>2</sup>	EDGE PROFILE 40 FOR STEPS EUR/m Item No. 62007
		<b>OAK AUSTER</b>					
	PvF	lively (accent)	bevelled, deep brushed	iDESIGN PARQUET*	61421	<b>82,50</b>	41,20
	PvF	lively (accent)	bevelled, scraped	iDESIGN PARQUET*	61417	<b>95,89</b>	43,98
	PvF	rustic (essence)	bevelled	iDESIGN PARQUET*	61525	<b>69,53</b>	38,63
	PvF	rustic (essence)	bevelled, brushed	iDESIGN PARQUET*	61505	<b>72,10</b>	39,14
	PvF	rustic (essence)	bevelled, deep brushed	iDESIGN PARQUET*	61717	<b>74,16</b>	39,55
	PvF	rustic (essence)	bevelled, intensely brushed	iDESIGN PARQUET*	61718	<b>84,46</b>	41,61
	PvF	rustic (essence)	bevelled, scraped	iDESIGN PARQUET*	61572	<b>87,55</b>	42,23

COLOUR RANGE	STONE				ITEM NO.	EUR/m <sup>2</sup>	EDGE PROFILE 40 FOR STEPS EUR/m Item No. 62007
		<b>OAK KASCHMIR</b>					
	PA+	calm (select)	bevelled, brushed	<b>STOCK ITEM</b>	61826	<b>84,87</b>	41,72
	PvF	calm (select)	bevelled	iDESIGN PARQUET*	61946	<b>92,08</b>	43,16
	PvF	calm (select)	bevelled, brushed	iDESIGN PARQUET*	61945	<b>94,66</b>	43,67
	PvF	calm (select)	bevelled, deep brushed	iDESIGN PARQUET*	61948	<b>96,72</b>	44,08
	PvF	calm (select)	bevelled, scraped	iDESIGN PARQUET*	61947	<b>110,11</b>	46,76
	PvF	lively (accent)	bevelled	iDESIGN PARQUET*	61942	<b>77,87</b>	40,27
	PvF	lively (accent)	bevelled, brushed	iDESIGN PARQUET*	61941	<b>80,44</b>	40,79
	PvF	lively (accent)	bevelled, deep brushed	iDESIGN PARQUET*	61944	<b>82,50</b>	41,20
	PvF	lively (accent)	bevelled, scraped	iDESIGN PARQUET*	61943	<b>95,89</b>	43,98
	PvF	rustic (essence)	bevelled	iDESIGN PARQUET*	61921	<b>69,53</b>	38,63
	PvF	rustic (essence)	bevelled, brushed	iDESIGN PARQUET*	61922	<b>72,10</b>	39,14
	PvF	rustic (essence)	bevelled, deep brushed	iDESIGN PARQUET*	61919	<b>74,16</b>	39,55
	PvF	rustic (essence)	bevelled, intensely brushed	iDESIGN PARQUET*	61918	<b>84,46</b>	41,61
	PvF	rustic (essence)	bevelled, scraped	iDESIGN PARQUET*	61920	<b>87,55</b>	42,23
	PA+	lively colourful (spectrum)	bevelled, brushed	<b>STOCK ITEM</b>	61825	<b>66,13</b>	37,90

SURCHARGE EDGE PROFILES		EUR/m
EDGE PROFILE 40 SYLE		+ 3,60
EDGE PROFILE 58 SYLE		+ 5,67
EDGE PROFILE BLOCK SYLE (riser is supplied loose)		+ 55,72

All prices for WP Multi and Extras can be found on page 93



## WP QUADRA 1800

3-layer | Dimensions: 1800 x 175 x 14 mm | 1 Package = 1,89 m<sup>2</sup>

COLOUR RANGE STONE		OAK ICE			ITEM NO.	EUR/m <sup>2</sup>	EDGE PROFILE 40 FOR STEPS EUR/m Item No. 62007
	PVf	calm (select)	bevelled, deep brushed	iDESIGN PARQUET®	61819	100,84	44,91
	PVf	calm (select)	bevelled, scraped	iDESIGN PARQUET®	61818	114,23	47,59
	PVf	lively (accent)	bevelled, deep brushed	iDESIGN PARQUET®	61817	86,62	42,13
	PVf	lively (accent)	bevelled, scraped	iDESIGN PARQUET®	61816	100,01	44,80
	PVf	rustic (essence)	bevelled, deep brushed	iDESIGN PARQUET®	61821	78,28	40,38
	PVf	rustic (essence)	bevelled, intensely brushed	iDESIGN PARQUET®	61822	88,58	42,44
	PVf	rustic (essence)	bevelled, scraped	iDESIGN PARQUET®	61820	91,67	43,05

COLOUR RANGE STONE		OAK SAVANNE			ITEM NO.	EUR/m <sup>2</sup>	EDGE PROFILE 40 FOR STEPS EUR/m Item No. 62007
	PA+	calm (select)	bevelled, brushed	STOCK ITEM	61547	84,87	41,72
	PVf	calm (select)	bevelled	iDESIGN PARQUET®	61532	92,08	43,16
	PVf	calm (select)	bevelled, brushed	iDESIGN PARQUET®	61533	94,66	43,67
	PVf	calm (select)	bevelled, deep brushed	iDESIGN PARQUET®	61530	96,72	44,08
	PVf	calm (select)	bevelled, scraped	iDESIGN PARQUET®	61531	110,11	46,76
	PA+	lively (accent)	bevelled, brushed	STOCK ITEM	61548	70,66	38,83
	PVf	lively (accent)	bevelled	iDESIGN PARQUET®	61541	77,87	40,27
	PVf	lively (accent)	bevelled, brushed	iDESIGN PARQUET®	61542	80,44	40,79
	PVf	lively (accent)	bevelled, deep brushed	iDESIGN PARQUET®	61539	82,50	41,20
	PVf	lively (accent)	bevelled, scraped	iDESIGN PARQUET®	61540	95,89	43,98
	PVf	rustic (essence)	bevelled	iDESIGN PARQUET®	61518	69,53	38,63
	PVf	rustic (essence)	bevelled, brushed	iDESIGN PARQUET®	61519	72,10	39,14
	PVf	rustic (essence)	bevelled, deep brushed	iDESIGN PARQUET®	61516	72,10	39,14
	PVf	rustic (essence)	bevelled, intensely brushed	iDESIGN PARQUET®	61515	84,46	41,61
	PVf	rustic (essence)	bevelled, scraped	iDESIGN PARQUET®	61517	87,55	42,23

## SURCHARGE EDGE PROFILES

EUR/m

EDGE PROFILE 40 SYLE

+ 3,60

EDGE PROFILE 58 SYLE

+ 5,67

EDGE PROFILE BLOCK SYLE (riser is supplied loose)

+ 55,72

All prices for WP Multi and Extras can be found on page 93



**Stock item delivery time:** promptly ex works (from 200 m<sup>2</sup> on request) | **iDesign Parkett delivery time (from 20 m<sup>2</sup> per item):** three to max. four weeks ex works (A flat LP surcharge of 400 EUR is billed under 20 m<sup>2</sup>). All deliveries are based on the General Terms and Conditions of Business of Weitzer Parkett. All rights reserved for changes, composition and printing errors.

## WP QUADRA 1800

3-layer | Dimensions: 1800 x 175 x 14 mm | 1 Package = 1,89 m<sup>2</sup>



COLOUR RANGE	STONE				ITEM NO.	EUR/m <sup>2</sup>	EDGE PROFILE 40 FOR STEPS EUR/m Item No. 62007
		<b>OAK POLAR</b>					
	Pvf	calm (select)	bevelled	iDESIGN PARQUET*	61846	<b>96,20</b>	43,98
	Pvf	calm (select)	bevelled, brushed	iDESIGN PARQUET*	61847	<b>98,78</b>	44,50
	Pvf	calm (select)	bevelled, deep brushed	iDESIGN PARQUET*	61844	<b>100,84</b>	44,91
	Pvf	calm (select)	bevelled, scraped	iDESIGN PARQUET*	61845	<b>114,23</b>	47,59
	Pvf	lively (accent)	bevelled	iDESIGN PARQUET*	61854	<b>81,99</b>	41,10
	Pvf	lively (accent)	bevelled, brushed	iDESIGN PARQUET*	61855	<b>84,56</b>	41,61
	Pvf	lively (accent)	bevelled, deep brushed	iDESIGN PARQUET*	61852	<b>86,62</b>	42,13
	Pvf	lively (accent)	bevelled, scraped	iDESIGN PARQUET*	61853	<b>100,01</b>	44,80
	Pvf	rustic (essence)	bevelled	iDESIGN PARQUET*	61837	<b>73,65</b>	39,45
	Pvf	rustic (essence)	bevelled, brushed	iDESIGN PARQUET*	61838	<b>76,22</b>	39,96
	Pvf	rustic (essence)	bevelled, deep brushed	iDESIGN PARQUET*	61835	<b>78,28</b>	40,38
	Pvf	rustic (essence)	bevelled, intensely brushed	iDESIGN PARQUET*	61834	<b>88,58</b>	42,44
	Pvf	rustic (essence)	bevelled, scraped	iDESIGN PARQUET*	61836	<b>91,67</b>	43,05

COLOUR RANGE	STONE				ITEM NO.	EUR/m <sup>2</sup>	EDGE PROFILE 40 FOR STEPS EUR/m Item No. 62007
		<b>OAK TRÜFFELGRAU</b>					
	Pvf	calm (select)	bevelled	iDESIGN PARQUET*	63799	<b>96,20</b>	43,98
	Pvf	calm (select)	bevelled, brushed	iDESIGN PARQUET*	61467	<b>98,78</b>	44,50
	Pvf	calm (select)	bevelled, deep brushed	iDESIGN PARQUET*	61463	<b>100,84</b>	44,91
	Pvf	calm (select)	bevelled, scraped	iDESIGN PARQUET*	61464	<b>114,23</b>	47,59
	Pvf	lively (accent)	bevelled	iDESIGN PARQUET*	61480	<b>81,99</b>	41,10
	Pvf	lively (accent)	bevelled, brushed	iDESIGN PARQUET*	63797	<b>84,56</b>	41,61
	Pvf	lively (accent)	bevelled, deep brushed	iDESIGN PARQUET*	63798	<b>86,62</b>	42,13
	Pvf	lively (accent)	bevelled, scraped	iDESIGN PARQUET*	61479	<b>100,01</b>	44,80
	Pvf	rustic (essence)	bevelled	iDESIGN PARQUET*	61436	<b>73,65</b>	39,45
	Pvf	rustic (essence)	bevelled, brushed	iDESIGN PARQUET*	63800	<b>76,22</b>	39,96
	Pvf	rustic (essence)	bevelled, deep brushed	iDESIGN PARQUET*	61423	<b>78,28</b>	40,38
	Pvf	rustic (essence)	bevelled, intensely brushed	iDESIGN PARQUET*	63801	<b>88,58</b>	42,44
	Pvf	rustic (essence)	bevelled, scraped	iDESIGN PARQUET*	61427	<b>91,67</b>	43,05

SURCHARGE EDGE PROFILES		EUR/m
EDGE PROFILE 40 SYLE		+ 3,60
EDGE PROFILE 58 SYLE		+ 5,67
EDGE PROFILE BLOCK SYLE (riser is supplied loose)		+ 55,72

All prices for WP Multi and Extras can be found on page 93

## WP QUADRA 1800

3-layer | Dimensions: 1800 x 175 x 14 mm | 1 Package = 1,89 m<sup>2</sup>

COLOUR RANGE STONE		OAK TAUPE		ITEM NO.	EUR/m <sup>2</sup>	EDGE PROFILE 40 FOR STEPS EUR/m Item No. 62007
	PVf calm (select)	bevelled	iDESIGN PARQUET®	61496	<b>92,08</b>	43,16
	PVf calm (select)	bevelled, brushed	iDESIGN PARQUET®	61497	<b>94,66</b>	43,67
	PVf calm (select)	bevelled, deep brushed	iDESIGN PARQUET®	61494	<b>96,72</b>	44,08
	PVf calm (select)	bevelled, scraped	iDESIGN PARQUET®	61495	<b>110,11</b>	46,76
	PVf lively (accent)	bevelled	iDESIGN PARQUET®	61508	<b>77,87</b>	40,27
	PVf lively (accent)	bevelled, brushed	iDESIGN PARQUET®	61509	<b>80,44</b>	40,79
	PVf lively (accent)	bevelled, deep brushed	iDESIGN PARQUET®	61506	<b>82,50</b>	41,20
	PVf lively (accent)	bevelled, scraped	iDESIGN PARQUET®	61507	<b>95,89</b>	43,98
	PVf rustic (essence)	bevelled	iDESIGN PARQUET®	61486	<b>69,53</b>	38,63
	PVf rustic (essence)	bevelled, brushed	iDESIGN PARQUET®	61487	<b>72,10</b>	39,14
	PVf rustic (essence)	bevelled, deep brushed	iDESIGN PARQUET®	61484	<b>74,16</b>	39,55
	PVf rustic (essence)	bevelled, intensely brushed	iDESIGN PARQUET®	61483	<b>84,46</b>	41,61
	PVf rustic (essence)	bevelled, scraped	iDESIGN PARQUET®	61485	<b>87,55</b>	42,23

## SURCHARGE EDGE PROFILES

EUR/m

EDGE PROFILE 40 SYLE	+ 3,60
EDGE PROFILE 58 SYLE	+ 5,67
EDGE PROFILE BLOCK SYLE (riser is supplied loose)	+ 55,72

All prices for WP Multi and Extras can be found on page 93



**Stock item delivery time:** promptly ex works (from 200 m<sup>2</sup> on request) | **iDesign Parkett delivery time (from 20 m<sup>2</sup> per item):** three to max. four weeks ex works (A flat LP surcharge of 400 EUR is billed under 20 m<sup>2</sup>). All deliveries are based on the General Terms and Conditions of Business of Weitzer Parkett. All rights reserved for changes, composition and printing errors.



## WP QUADRA 1800 WOODEN STAIRS WP MULTI

Prices apply for all colours, surface finishes, grades, and additional treatments.

PROFILE 40	SPECIES	TREAD PANEL without Carrier panel   Item No.: 29878		RISER Item No.: 54283	WALL COVERING Item No.: 54319
		EURO/ STEPS/linear meters straight	EURO/ STEPS/linear meters L- and U-SHAPED	EURO/ STEPS/linear meters	EURO/ linear meters
	Fumed Oak (WP Quadra)	<b>103,93</b>	<b>122,16</b>	<b>52,94</b>	<b>83,12</b>
	Nut steamed (WP Quadra)	<b>126,79</b>	<b>148,94</b>	<b>64,89</b>	<b>101,35</b>
	Oak (WP Quadra 1800)	<b>89,20</b>	<b>104,85</b>	<b>45,42</b>	<b>71,38</b>
	White (RAL 9010)	-	-	<b>21,22</b>	-
SURCHARGE					
<b>PROFILE 40 STYLE</b>		<b>15,14</b>	<b>15,14</b>	-	-
<b>PROFILE 58 STYLE</b>		<b>17,20</b>	<b>17,20</b>	-	-
<b>PROFILE BLOCK STYLE</b>		<b>55,72</b>	<b>55,72</b>	Riser is included in the price and is supplied loose.	-
<b>Continuous top layer, no header joint</b> Up to product length		<b>+ 30 %</b>	<b>+ 30 %</b>	Riser panel will be delivered as one continuous piece of plank	<b>+ 30 %</b>
<b>Carrier panel</b> 6 mm, 17 mm or 27 mm		<b>15,04</b>	<b>15,04</b>	<b>9,17</b>	<b>9,17</b>
<b>Customization</b> Only possible with digital measuring system or stencils/moulds		<b>14,63</b>	<b>17,41</b>	<b>15,96</b>	Is customized
<b>Riser pre-drilled, including screws</b> Minimum thickness 19 mm		-	-	<b>13,70</b>	-
SURCHARGE					
<b>iDESIGN PARKETT®</b>	all species	<b>6,18</b>	<b>6,18</b>	<b>6,18</b>	<b>6,18</b>

Orders for prefab tread panels possible using the WP Multi measurement sheet.  
Templates for download from Weitzer Parkett Partner Portal.

WOODEN STAIRS WP MULTI   EXTRAS					
<b>Multi Front Edge (FE)</b> <b>PROFILE 40, 40 STYLE, BLOCK STYLE</b> Item No.: 40272   right/left   available on request without a tongue	350 mm   EURO/pc.	<b>10,51</b>	600 mm   EURO/pc.	<b>13,49</b>	
<b>Multi Front Edge (FE)</b> <b>PROFILE 58 STYLE</b> Item No.: 40272   right/left   available on request without a tongue	350 mm   EURO/pc.	<b>11,54</b>	600 mm   EURO/pc.	<b>14,52</b>	
<b>Multi Wall Cover Moulding (WCM)</b> <b>PROFILE 40, 40 STYLE, 58 STYLE BLOCK STYLE</b> Item No.: 40281   right/left, straight/L- and U-shaped	350 mm   EURO/pc.	<b>10,51</b>	650 mm   EURO/pc.	<b>19,47</b>	
<b>Multi Front Edge - Riser (FER)</b> <b>PROFILE 40/58 STYLE</b> for riser Item No.: 40463	white   EURO/lm	<b>6,90</b>	Species   EURO/lm Item No.: 40279	<b>12,77</b>	
<b>Multi Landing Wall Cover Moulding</b> Item No.: 40627	40 x 14 mm   EURO/lm		<b>15,35</b>		
<b>Multi Front Edge (FE) execute</b> for treads including material	Tread Panel + wall covering EURO/pc.		<b>23,18</b>		
<b>Edge Profile for Stairs 40 (LEP)</b> Item No.: 54295 Dimensions: 40 mm x 14 mm   curvature/radius: 3 mm Fixed length: 2500 mm	Colour range <b>LAVA/TERRA</b> EURO/lm	<b>20,19</b>	remaining colour scheme EURO/lm	<b>16,07</b>	

Further extras and detailed descriptions from page 141!







# WIDEBOARD APPEARANCE

## OFFERS SPACIOUSNESS

PROVIDES A ROOM WITH STYLE AND DISTINCTIVENESS, WORKS WELL IN ALL SURROUNDINGS. THE SPECIAL FORMAT BETWEEN PLANK AND BLOCK. ITS GENEROUS APPEARANCE MAKES IT PERFECTLY SUITED TO LARGE OR SMALL AREAS.



## WP 4140

## 2-LAYER PARQUET



- Luxurious format with an extremely wide choice of wood species, finishes and surfaces
- Tongue and groove joint on four sides **(01)**
- Tailor-made and dimensionally stable header joint by utilizing top-quality plywood **(02)**
- Spruce supporting material with vertically arranged growth rings **(03)**
- Bevel on the longitudinal and header joints **(04)**
- Ideally suited to underfloor heating, thanks to ideal overall thickness

**Herringbone\* and French Herringbone\* installation:**

- All articles in all surfaces are suitable for Herringbone installation
  - Joint-edge impregnation is recommended
- For French Herringbone installation:
  - Inquiry possible for 60° and 45° laying
  - All items except **bevelled** in PS and PA+ suitable!
  - Joint-edge impregnation is recommended

\* from an order of 20 m<sup>2</sup>

## DIMENSIONS:

1400 x 140 x 11 mm

Overall thickness 11 mm with approx. 3,6 mm wear layer

0 cm 100 cm 200 cm 300 cm 350 cm

## PACKING UNITS

UNIT	PACKAGE	PALLET
CONTENTS	10 boards = 1,96 m <sup>2</sup>	56 packages = 109,76 m <sup>2</sup>
DIMENSIONS	1,415 x 0,155 x 0,12 m	1,415 x 1,080 x 0,96 m
WEIGHT	approx. 12,29 kg	approx. 700 kg
EDGE PROFILE FOR STEPS	Fixed length: 1,40 m; profile 40, 40 style, 58 style and block style; Profile block style: riser is delivered loose.	

## PACKING UNITS FRENCH HERRINGBONE

French Herringbone 45° = 1,76 m<sup>2</sup> per unitFrench Herringbone 60° = 1,85 m<sup>2</sup> per unit

## WP 4100

### 2-LAYER PARQUET



- Available in an extremely wide choice of wood species, finishes and surfaces
- Tongue and groove joint on four sides **(01)**
- Tailor-made and dimensionally stable header joint by utilizing top-quality plywood **(02)**
- Spruce supporting material with vertically arranged growth rings **(03)**
- Can be used in combination with WP 450



#### Herringbone\* and French Herringbone\* installation:

- All articles in all surfaces are suitable for Herringbone installation
  - Joint-edge impregnation is recommended
- For French Herringbone installation:
  - Inquiry possible for 60° and 45° laying
  - All items except **bevelled** in PS and PA+ suitable!
  - Joint-edge impregnation is recommended

\* from an order of 20 m<sup>2</sup>

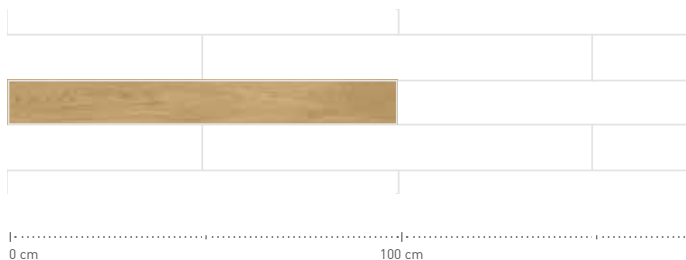

#### DIMENSIONS:

1000 x 125 x 11 mm  
Overall thickness 11 mm with approx. 3,6 mm wear layer

#### PACKING UNITS

UNIT	PACKAGE	PALLET
CONTENTS	12 boards = 1,50 m <sup>2</sup>	64 packages = 96,00 m <sup>2</sup>
DIMENSIONS	1,01 x 0,14 x 0,14 m	1,20 x 1,03 x 1,26 m
WEIGHT	approx. 9,20 kg	approx. 588,80 kg
EDGE PROFILE FOR STEPS	Fixed length: 1 m or 2 m; Profile 40, 40 style, 58 style and block style; Profile Block style: riser is delivered loose.	

#### PACKING UNITS FRENCH HERRINGBONE

**French Herringbone 45°** = 1,31 m<sup>2</sup> per unit  
**French Herringbone 60°** = 1,38 m<sup>2</sup> per unit

## WP CHARISMA 2-STRIP

## 3-LAYER PARQUET



- Intelligent patented double-click system with the greatest interlocking power on the market. **(01)**
- Patented press-stud principle for simultaneous locking of the longitudinal and header joints in one movement **(02)**:
  - Fast and simple one-man assembly and disassembly
  - Can be completely adhered to the subfloor\*
- Header joint edge locking mechanism made from solid hardwood only - completely free from plastic components and plasticizers **(03)**
- Spruce supporting material with vertically arranged growth rings **(04)**
- HydroStop:
  - Unique all-round joint-edge impregnation
  - Provides the ultimate protection against the ingress of moisture due to small spillages
- **NOW NEW:** The WP rotatable plank allows a simple modification of the laying direction

\* Ideally suited to underfloor heating, as it can be completely adhered to the subfloor

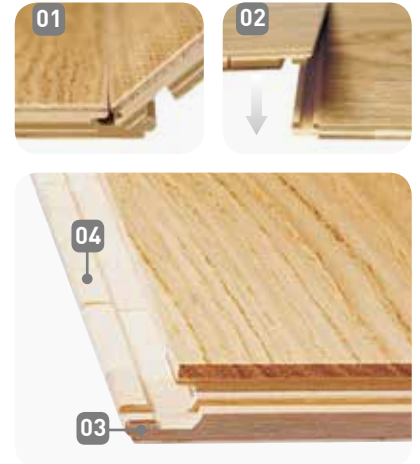

## DIMENSIONS:

2245 x 193 x 14 mm

Overall thickness 14 mm with approx. 3,6 mm wear layer

0 cm 100 cm 200 cm 300 cm 350 cm

















## PACKAGING UNIT

UNIT	PACKAGE	PALLET
CONTENTS	6 boards = 2,60 m <sup>2</sup>	35 packages = 91,00 m <sup>2</sup>
DIMENSIONS	2,28 x 0,215 x 0,085 m	2,28 x 1,10 x 0,71 m
WEIGHT	approx. 19,80 kg	approx. 693 kg
EDGE PROFILE FOR STEPS	Fixed length: 2,245 m; Profile 40, 40 style, 58 style and block style; Profile block style: riser is delivered loose.	



## COLOUR RANGE OVERVIEW

### STOCK ITEM

 <p>COLOUR RANGE <b>LAVA</b> <b>FUMED OAK ICE</b> lively (original*)</p> <ul style="list-style-type: none"> <li>WP Charisma 2-Strip</li> </ul>	 <p>COLOUR RANGE <b>LAVA</b> <b>FUMED OAK</b> lively (original*)</p> <ul style="list-style-type: none"> <li>WP 4100</li> </ul>	 <p>COLOUR RANGE <b>TERRA</b> <b>OAK COFFEE</b> lively (original*)</p> <ul style="list-style-type: none"> <li>WP 4100</li> </ul>	 <p>COLOUR RANGE <b>TERRA</b> <b>NUT STEAMED</b> lively colourful (structure)</p> <ul style="list-style-type: none"> <li>WP Charisma 2-Strip</li> <li>WP 4100</li> </ul>	 <p>COLOUR RANGE <b>FIRE</b> <b>ROBINIA STEAMED</b> lively colourful (original)</p> <ul style="list-style-type: none"> <li>WP 4100</li> </ul>
 <p>COLOUR RANGE <b>NATUR</b> <b>OAK</b> calm (select)</p> <ul style="list-style-type: none"> <li>WP 4140, WP 4100</li> </ul>	 <p>COLOUR RANGE <b>NATUR</b> <b>OAK</b> lively (original*)</p> <ul style="list-style-type: none"> <li>WP Charisma 2-Strip</li> </ul>	 <p>COLOUR RANGE <b>NATUR</b> <b>OAK</b> lively (accent)</p> <ul style="list-style-type: none"> <li>WP 4140</li> <li>WP 4100</li> </ul>	 <p>COLOUR RANGE <b>NATUR</b> <b>OAK PURE</b> calm (select)</p> <ul style="list-style-type: none"> <li>WP 4140</li> </ul>	 <p>COLOUR RANGE <b>STONE</b> <b>OAK AUSTER</b> calm (select)</p> <ul style="list-style-type: none"> <li>WP 4140</li> </ul>
 <p>COLOUR RANGE <b>STONE</b> <b>OAK COLORADO</b> <b>DIAMOND ICE</b> lively colourful (spectrum)</p> <ul style="list-style-type: none"> <li>WP 4100</li> </ul>	 <p>COLOUR RANGE <b>STONE</b> <b>OAK KASCHMIR</b> calm (nature)</p> <ul style="list-style-type: none"> <li>WP 4140, WP 4100</li> </ul>	 <p>COLOUR RANGE <b>STONE</b> <b>OAK KASCHMIR</b> lively (accent)</p> <ul style="list-style-type: none"> <li>WP 4140</li> <li>WP Charisma 2-Strip</li> </ul>	 <p>COLOUR RANGE <b>STONE</b> <b>OAK KASCHMIR</b> lively colourful (spectrum)</p> <ul style="list-style-type: none"> <li>WP 4100</li> </ul>	 <p>COLOUR RANGE <b>STONE</b> <b>OAK ICE</b> lively (original*)</p> <ul style="list-style-type: none"> <li>WP 4140</li> </ul>
 <p>COLOUR RANGE <b>STONE</b> <b>OAK SAVANNE</b> calm (select)</p> <ul style="list-style-type: none"> <li>WP 4140</li> </ul>	 <p>COLOUR RANGE <b>STONE</b> <b>ASH POLAR</b> lively colourful (natural)</p> <ul style="list-style-type: none"> <li>WP Charisma 2-Strip</li> </ul>			

\*no sapwood



The grading overview serves as a rough orientation. To obtain a representative grading picture please see our official grading book or get info from our partner portal:  
<https://partner.weitzer-parkett.com>





## WP 4140

2-layer | Dimensions: 1400 x 140 x 11 mm | 1 Package = 1,96 m<sup>2</sup>

COLOUR RANGE				ITEM NO.	EUR/m <sup>2</sup>	EDGE PROFILE 40 FOR STEPS EUR/lm Item No. 29884	
LAVA	FUMED OAK MELANGE						
		PVf lively (original*)	bevelled	iDESIGN PARQUET*	42833	98,57	38,63
		PVf lively (original*)	bevelled, brushed	iDESIGN PARQUET*	42831	101,15	39,04
		PVf lively (original*)	bevelled, deep brushed	iDESIGN PARQUET*	42832	103,21	39,35
		PVf lively (original*)	bevelled, intensely brushed	iDESIGN PARQUET*	49690	113,51	40,99
		PVf lively (original*)	bevelled, scraped	iDESIGN PARQUET*	50754	116,60	41,51
LAVA	FUMED OAK						
		PVf lively (original*)	bevelled	iDESIGN PARQUET*	27772	88,79	37,08
		PVf lively (original*)	bevelled, brushed	iDESIGN PARQUET*	27763	91,36	37,49
		PVf lively (original*)	bevelled, deep brushed	iDESIGN PARQUET*	42038	93,42	37,80
		PVf lively (original*)	bevelled, intensely brushed	iDESIGN PARQUET*	50781	103,72	39,45
		PVf lively (original*)	bevelled, scraped	iDESIGN PARQUET*	50782	106,81	39,96
TERRA	OAK COFFEE						
		PVf lively (original*)	bevelled	iDESIGN PARQUET*	50780	88,79	37,08
	PVf lively (original*)	bevelled, brushed	iDESIGN PARQUET*	42041	91,36	37,49	
TERRA	OAK KROKANT						
		PVf calm (select)	bevelled	iDESIGN PARQUET*	42898	85,49	36,26
		PVf calm (select)	bevelled, brushed	iDESIGN PARQUET*	42899	88,07	36,67
		PVf calm (select)	bevelled, deep brushed	iDESIGN PARQUET*	42900	90,13	36,98
		PVf calm (select)	bevelled, scraped	iDESIGN PARQUET*	51525	103,52	39,14
		PVf lively (accent)	bevelled	iDESIGN PARQUET*	42903	72,62	34,09
		PVf lively (accent)	bevelled, brushed	iDESIGN PARQUET*	42904	75,19	34,51
		PVf lively (accent)	bevelled, deep brushed	iDESIGN PARQUET*	51594	77,25	34,92
		PVf lively (accent)	bevelled, intensely brushed	iDESIGN PARQUET*	51490	87,55	36,56

\*no sapwood

SURCHARGE EDGE PROFILES	EUR/lm	SURCHARGE HERRINGBONE	EUR/m <sup>2</sup>
EDGE PROFILE 40 SYLE	+ 15,45	HERRINGBONE 90°	+ 4,12
EDGE PROFILE 58 SYLE	+ 17,51	FRENCH HERRINGBONE 60°/45°	+ 20,09
EDGE PROFILE BLOCK STYLE (riser is supplied loose)	+ 60,77	All items except bevelled in PS and PA+ suitable!	

All prices for WP Multi and Extras can be found on page 106



**Stock item delivery time:** promptly ex works (from 200 m<sup>2</sup> on request) | **iDesign Parkett delivery time (from 20 m<sup>2</sup> per item):** three to max. four weeks ex works (A flat LP surcharge of 400 EUR is billed under 20 m<sup>2</sup>).  
All deliveries are based on the General Terms and Conditions of Business of Weitzer Parkett. All rights reserved for changes, composition and printing errors.

## WP 4140

2-layer | Dimensions: 1400 x 140 x 11 mm | 1 Package = 1,96 m<sup>2</sup>



COLOUR RANGE TERRA				ITEM NO.	EUR/m <sup>2</sup>	EDGE PROFILE 40 FOR STEPS EUR/m Item No. 29884	
	<b>OAK KROKANT</b>						
	PVf	lively (accent)	bevelled, scraped	iDESIGN PARQUET*	51529	<b>90,64</b>	37,08

COLOUR RANGE NATURE				ITEM NO.	EUR/m <sup>2</sup>	EDGE PROFILE 40 FOR STEPS EUR/m Item No. 29884	
	<b>OAK MANDEL</b>						
	PVf	calm (select)	bevelled	iDESIGN PARQUET*	27944	<b>85,49</b>	36,26
	PVf	calm (select)	bevelled, brushed	iDESIGN PARQUET*	27945	<b>88,07</b>	36,67
	PVf	calm (select)	bevelled, deep brushed	iDESIGN PARQUET*	53961	<b>90,13</b>	36,98
	PVf	calm (select)	bevelled, scraped	iDESIGN PARQUET*	51811	<b>103,52</b>	39,14

	PVf	lively (accent)	bevelled	iDESIGN PARQUET*	27946	<b>72,62</b>	34,09
	PVf	lively (accent)	bevelled, brushed	iDESIGN PARQUET*	27947	<b>75,19</b>	34,51
	PVf	lively (accent)	bevelled, deep brushed	iDESIGN PARQUET*	50764	<b>77,25</b>	34,92
	PVf	lively (accent)	bevelled, intensely brushed	iDESIGN PARQUET*	51774	<b>87,55</b>	36,56
	PVf	lively (accent)	bevelled, scraped	iDESIGN PARQUET*	51812	<b>90,64</b>	37,08

COLOUR RANGE NATURE				ITEM NO.	EUR/m <sup>2</sup>	EDGE PROFILE 40 FOR STEPS EUR/m Item No. 29884	
	<b>OAK</b>						
	PA+	calm (select)	bevelled, brushed	<b>STOCK ITEM</b>	27754	<b>74,16</b>	31,31
	PVf	calm (select)	bevelled	iDESIGN PARQUET*	27773	<b>79,83</b>	32,24
	PVf	calm (select)	bevelled, brushed	iDESIGN PARQUET*	27767	<b>82,40</b>	32,65
	PVf	calm (select)	bevelled, deep brushed	iDESIGN PARQUET*	42042	<b>84,46</b>	32,96
	PVf	calm (select)	bevelled, scraped	iDESIGN PARQUET*	51954	<b>97,85</b>	35,12

	PA+	lively (accent)		<b>STOCK ITEM</b>	57045	<b>56,65</b>	28,43
	PA+	lively (accent)	bevelled, brushed	<b>STOCK ITEM</b>	27755	<b>61,29</b>	29,25
	PVf	lively (accent)	bevelled	iDESIGN PARQUET*	27774	<b>66,95</b>	30,18
	PVf	lively (accent)	bevelled, brushed	<b>STOCK ITEM</b>	27768	<b>63,35</b>	29,56
	PVf	lively (accent)	bevelled, deep brushed	iDESIGN PARQUET*	42046	<b>71,59</b>	30,90
	PVf	lively (accent)	bevelled, intensely brushed	iDESIGN PARQUET*	51920	<b>81,89</b>	32,55
	PVf	lively (accent)	bevelled, scraped	iDESIGN PARQUET*	51955	<b>84,98</b>	33,06

SURCHARGE EDGE PROFILES	EUR/m
EDGE PROFILE 40 SYLE	+ 15,45
EDGE PROFILE 58 SYLE	+ 17,51
EDGE PROFILE BLOCK STYLE (riser is supplied loose)	+ 60,77

All prices for WP Multi and Extras can be found on page 106

SURCHARGE HERRINGBONE	EUR/m <sup>2</sup>
HERRINGBONE 90°	+ 4,12
FRENCH HERRINGBONE 60°/45°	+ 20,09

All items except bevelled in PS and PA+ suitable!

## WP 4140

2-layer | Dimensions: 1400 x 140 x 11 mm | 1 Package = 1,96 m<sup>2</sup>

COLOUR RANGE: NATURE				ITEM NO.	EUR/m <sup>2</sup>	EDGE PROFILE 40 FOR STEPS EUR/lm Item No. 29884
	PA+ calm (select)	bevelled	<b>STOCK ITEM</b>	59852	<b>75,71</b>	34,61
	PVf calm (select)	bevelled	iDESIGN PARQUET*	50768	<b>85,49</b>	36,26
	PVf calm (select)	bevelled, brushed	iDESIGN PARQUET*	52051	<b>88,07</b>	36,67
	PVf calm (select)	bevelled, deep brushed	iDESIGN PARQUET*	52232	<b>90,13</b>	36,98
	PVf calm (select)	bevelled, scraped	iDESIGN PARQUET*	52152	<b>103,52</b>	39,14
	PVf lively (accent)	bevelled	iDESIGN PARQUET*	50769	<b>72,62</b>	34,09
	PVf lively (accent)	bevelled, brushed	iDESIGN PARQUET*	50123	<b>75,19</b>	34,51
	PVf lively (accent)	bevelled, deep brushed	iDESIGN PARQUET*	52233	<b>77,25</b>	34,92
	PVf lively (accent)	bevelled, intensely brushed	iDESIGN PARQUET*	52114	<b>87,55</b>	36,56
	PVf lively (accent)	bevelled, scraped	iDESIGN PARQUET*	52153	<b>90,64</b>	37,08

COLOUR RANGE: STONE				ITEM NO.	EUR/m <sup>2</sup>	EDGE PROFILE 40 FOR STEPS EUR/lm Item No. 29884
	PA+ calm (select)	bevelled, brushed	<b>STOCK ITEM</b>	27758	<b>78,28</b>	35,02
	PVf calm (select)	bevelled	iDESIGN PARQUET*	27957	<b>85,49</b>	36,26
	PVf calm (select)	bevelled, brushed	iDESIGN PARQUET*	27958	<b>88,07</b>	36,67
	PVf calm (select)	bevelled, deep brushed	iDESIGN PARQUET*	43690	<b>90,13</b>	36,98
	PVf calm (select)	bevelled, scraped	iDESIGN PARQUET*	52350	<b>103,52</b>	39,14
	PVf lively (accent)	bevelled	iDESIGN PARQUET*	27959	<b>72,62</b>	34,09
	PVf lively (accent)	bevelled, brushed	iDESIGN PARQUET*	27960	<b>75,19</b>	34,51
	PVf lively (accent)	bevelled, deep brushed	iDESIGN PARQUET*	50772	<b>77,25</b>	34,92
	PVf lively (accent)	bevelled, intensely brushed	iDESIGN PARQUET*	52303	<b>87,55</b>	36,56
	PVf lively (accent)	bevelled, scraped	iDESIGN PARQUET*	50332	<b>90,64</b>	37,08

COLOUR RANGE: STONE				ITEM NO.	EUR/m <sup>2</sup>	EDGE PROFILE 40 FOR STEPS EUR/lm Item No. 29884
	PA+ calm (select)	bevelled, brushed	<b>STOCK ITEM</b>	27759	<b>78,28</b>	35,02
	PVf calm (select)	bevelled	iDESIGN PARQUET*	27951	<b>85,49</b>	36,26
	PVf calm (select)	bevelled, brushed	iDESIGN PARQUET*	27952	<b>88,07</b>	36,67

SURCHARGE EDGE PROFILES	EUR/lm	SURCHARGE HERRINGBONE	EUR/m <sup>2</sup>
EDGE PROFILE 40 SYLE	+ 15,45	HERRINGBONE 90°	+ 4,12
EDGE PROFILE 58 SYLE	+ 17,51	FRENCH HERRINGBONE 60°/45°	+ 20,09
EDGE PROFILE BLOCK STYLE (riser is supplied loose)	+ 60,77	All items except bevelled in PS and PA+ suitable!	

All prices for WP Multi and Extras can be found on page 106



**Stock item delivery time:** promptly ex works (from 200 m<sup>2</sup> on request) | **iDesign Parkett delivery time (from 20 m<sup>2</sup> per item):** three to max. four weeks ex works (A flat LP surcharge of 400 EUR is billed under 20 m<sup>2</sup>.)  
All deliveries are based on the General Terms and Conditions of Business of Weitzer Parkett. All rights reserved for changes, composition and printing errors.

## WP 4140

2-layer | Dimensions: 1400 x 140 x 11 mm | 1 Package = 1,96 m<sup>2</sup>



COLOUR RANGE STONE				ITEM NO.	EUR/m <sup>2</sup>	EDGE PROFILE 40 FOR STEPS EUR/lm Item No. 29884
		<b>OAK KASCHMIR</b>				
	PvF	calm (select)	bevelled, deep brushed	iDESIGN PARQUET* 43839	<b>90,13</b>	36,98
	PvF	calm (select)	bevelled, scraped	iDESIGN PARQUET* 52462	<b>103,52</b>	39,14
	PA+	lively (accent)		<b>STOCK ITEM</b> 58527	<b>60,77</b>	32,24
	PvF	lively (accent)	bevelled	iDESIGN PARQUET* 27953	<b>72,62</b>	34,09
	PvF	lively (accent)	bevelled, brushed	iDESIGN PARQUET* 27954	<b>75,19</b>	34,51
	PvF	lively (accent)	bevelled, deep brushed	iDESIGN PARQUET* 50983	<b>77,25</b>	34,92
	PvF	lively (accent)	bevelled, intensely brushed	iDESIGN PARQUET* 52425	<b>87,55</b>	36,56
	PvF	lively (accent)	bevelled, scraped	iDESIGN PARQUET* 52463	<b>90,64</b>	37,08
		<b>OAK ICE</b>				
	PvF	calm (select)	bevelled, deep brushed	iDESIGN PARQUET* 43962	<b>94,25</b>	37,59
	PvF	calm (select)	bevelled, scraped	iDESIGN PARQUET* 50774	<b>107,64</b>	39,76
	PvF	lively (accent)	bevelled, deep brushed	<b>STOCK ITEM</b> 27770	<b>75,19</b>	34,51
	PvF	lively (accent)	bevelled, intensely brushed	iDESIGN PARQUET* 53762	<b>91,67</b>	37,18
	PvF	lively (accent)	bevelled, scraped	iDESIGN PARQUET* 50775	<b>94,76</b>	37,70
		<b>OAK SAVANNE</b>				
	PA+	calm (select)	bevelled, brushed	<b>STOCK ITEM</b> 27760	<b>78,28</b>	35,02
	PvF	calm (select)	bevelled	iDESIGN PARQUET* 50778	<b>85,49</b>	36,26
	PvF	calm (select)	bevelled, brushed	iDESIGN PARQUET* 52570	<b>88,07</b>	36,67
	PvF	calm (select)	bevelled, deep brushed	iDESIGN PARQUET* 52772	<b>90,13</b>	36,98
	PvF	calm (select)	bevelled, scraped	iDESIGN PARQUET* 52693	<b>103,52</b>	39,14
	PvF	lively (accent)	bevelled	iDESIGN PARQUET* 49694	<b>72,62</b>	34,09
	PvF	lively (accent)	bevelled, brushed	iDESIGN PARQUET* 52572	<b>75,19</b>	34,51
	PvF	lively (accent)	bevelled, deep brushed	iDESIGN PARQUET* 52773	<b>77,25</b>	34,92
	PvF	lively (accent)	bevelled, intensely brushed	iDESIGN PARQUET* 52660	<b>87,55</b>	36,56
	PvF	lively (accent)	bevelled, scraped	iDESIGN PARQUET* 52694	<b>90,64</b>	37,08

SURCHARGE EDGE PROFILES	EUR/lm
EDGE PROFILE 40 SYLE	+ 15,45
EDGE PROFILE 58 SYLE	+ 17,51
EDGE PROFILE BLOCK STYLE (riser is supplied loose)	+ 60,77

All prices for WP Multi and Extras can be found on page 106

SURCHARGE HERRINGBONE	EUR/m <sup>2</sup>
HERRINGBONE 90°	+ 4,12
FRENCH HERRINGBONE 60°/45°	+ 20,09

All items except bevelled in PS and PA+ suitable!

## WP 4140

2-layer | Dimensions: 1400 x 140 x 11 mm | 1 Package = 1,96 m<sup>2</sup>

COLOUR RANGE STONE		OAK POLAR		ITEM NO.	EUR/m <sup>2</sup>	EDGE PROFILE 40 FOR STEPS EUR/lm Item No. 29884
	PVf calm (select)	bevelled	iDESIGN PARQUET*	53965	89,61	36,87
	PVf calm (select)	bevelled, brushed	iDESIGN PARQUET*	44036	92,19	37,29
	PVf calm (select)	bevelled, deep brushed	iDESIGN PARQUET*	53021	94,25	37,59
	PVf calm (select)	bevelled, scraped	iDESIGN PARQUET*	52941	107,64	39,76
	PVf lively (accent)	bevelled	iDESIGN PARQUET*	52852	76,74	34,81
	PVf lively (accent)	bevelled, brushed	iDESIGN PARQUET*	44038	79,31	35,23
	PVf lively (accent)	bevelled, deep brushed	iDESIGN PARQUET*	53022	81,37	35,54
	PVf lively (accent)	bevelled, intensely brushed	iDESIGN PARQUET*	52902	91,67	37,18
	PVf lively (accent)	bevelled, scraped	iDESIGN PARQUET*	52942	94,76	37,70
COLOUR RANGE STONE		OAK TRÜFFELGRAU		ITEM NO.	EUR/m <sup>2</sup>	EDGE PROFILE 40 FOR STEPS EUR/lm Item No. 29884
	PVf calm (select)	bevelled	iDESIGN PARQUET*	63866	89,61	36,87
	PVf calm (select)	bevelled, brushed	iDESIGN PARQUET*	63864	92,19	37,29
	PVf calm (select)	bevelled, deep brushed	iDESIGN PARQUET*	63865	94,25	37,59
	PVf calm (select)	bevelled, scraped	iDESIGN PARQUET*	53436	107,64	39,76
	PVf lively (accent)	bevelled	iDESIGN PARQUET*	63861	76,74	34,81
	PVf lively (accent)	bevelled, brushed	iDESIGN PARQUET*	63860	79,31	35,23
	PVf lively (accent)	bevelled, deep brushed	iDESIGN PARQUET*	63862	81,37	35,54
	PVf lively (accent)	bevelled, intensely brushed	iDESIGN PARQUET*	63863	91,67	37,18
	PVf lively (accent)	bevelled, scraped	iDESIGN PARQUET*	53437	94,76	37,70
COLOUR RANGE STONE		OAK TAUPE		ITEM NO.	EUR/m <sup>2</sup>	EDGE PROFILE 40 FOR STEPS EUR/lm Item No. 29884
	PVf calm (select)	bevelled	iDESIGN PARQUET*	53116	85,49	36,26
	PVf calm (select)	bevelled, brushed	iDESIGN PARQUET*	44128	88,07	36,67
	PVf calm (select)	bevelled, deep brushed	iDESIGN PARQUET*	53284	90,13	36,98
	PVf calm (select)	bevelled, scraped	iDESIGN PARQUET*	53202	103,52	39,14
	PVf lively (accent)	bevelled	iDESIGN PARQUET*	53117	72,62	34,09

## SURCHARGE EDGE PROFILES

EUR/lm

EDGE PROFILE 40 SYLE

+ 15,45

EDGE PROFILE 58 SYLE

+ 17,51

EDGE PROFILE BLOCK STYLE (riser is supplied loose)

+ 60,77

## SURCHARGE HERRINGBONE

EUR/m<sup>2</sup>

HERRINGBONE 90°

+ 4,12

FRENCH HERRINGBONE 60°/45°

+ 20,09

All items except bevelled in PS and PA+ suitable!

All prices for WP Multi and Extras can be found on page 106



Stock item delivery time: promptly ex works (from 200 m<sup>2</sup> on request) | iDesign Parkett delivery time (from 20 m<sup>2</sup> per item): three to max. four weeks ex works (A flat LP surcharge of 400 EUR is billed under 20 m<sup>2</sup>). All deliveries are based on the General Terms and Conditions of Business of Weitzer Parkett. All rights reserved for changes, composition and printing errors.



## WP 4140

2-layer | Dimensions: 1400 x 140 x 11 mm | 1 Package = 1,96 m<sup>2</sup>



COLOUR RANGE STONE			OAK TAUPE	ITEM NO.	EUR/m <sup>2</sup>	EDGE PROFILE 40	
						FOR STEPS	
EUR/m							
Item No. 29884							
	PVf	lively (accent)	bevelled, brushed	iDESIGN PARQUET*	44130	75,19	34,51
	PVf	lively (accent)	bevelled, deep brushed	iDESIGN PARQUET*	53285	77,25	34,92
	PVf	lively (accent)	bevelled, intensely brushed	iDESIGN PARQUET*	53163	87,55	36,56
	PVf	lively (accent)	bevelled, scraped	iDESIGN PARQUET*	53203	90,64	37,08

SURCHARGE EDGE PROFILES	EUR/m	SURCHARGE HERRINGBONE	EUR/m <sup>2</sup>
EDGE PROFILE 40 SYLE	+ 15,45	HERRINGBONE 90°	+ 4,12
EDGE PROFILE 58 SYLE	+ 17,51	FRENCH HERRINGBONE 60°/45°	+ 20,09
EDGE PROFILE BLOCK STYLE (riser is supplied loose)	+ 60,77	All items except bevelled in PS and PA+ suitable!	

All prices for WP Multi and Extras can be found on page 106

**WP 4140**  
**WOODEN STAIRS WP MULTI**Prices apply for all colours, surface finishes,  
grades, and additional treatments.

PROFILE 40	SPECIES	TREAD PANEL including carrier panel (6 mm, 17 mm or 27 mm)   Item No.: 29868		RISER Item No.: 54275	WALL COVERING Item No.: 54300
		EURO/ STEPS/linear meters straight	EURO/ STEPS/linear meters L- and U-SHAPED	EURO/ STEPS/linear meters	EURO EURO/ linear meters/lm
	Fumed Oak	<b>110,73</b>	<b>130,09</b>	<b>56,24</b>	<b>88,37</b>
	Oak Coffee	<b>110,73</b>	<b>130,09</b>	<b>56,24</b>	<b>88,37</b>
	Oak	<b>99,29</b>	<b>116,70</b>	<b>50,47</b>	<b>79,21</b>
	White (RAL 9010)	-	-	<b>21,22</b>	-
<b>SURCHARGE</b>					
<b>PROFILE 40 STYLE</b>		<b>15,45</b>	<b>15,45</b>	-	-
<b>PROFILE 58 STYLE</b>		<b>17,51</b>	<b>17,51</b>	-	-
<b>PROFILE BLOCK STYLE</b>		<b>60,77</b>	<b>60,77</b>	Riser is included in the price and is supplied loose.	-
<b>Continuous top layer, no header joint</b> Up to product length		<b>+ 30 %</b>	<b>+ 30 %</b>	Riser panel will be delivered as one continuous piece of plank	<b>+ 30 %</b>
<b>Customization</b> Only possible with digital measuring system or stencils/moulds		<b>14,63</b>	<b>17,41</b>	<b>15,96</b>	Is customized
<b>Riser pre-drilled, including screws</b> Minimum thickness 19 mm		-	-	<b>13,70</b>	-
<b>SURCHARGE</b>		<b>TREAD PANEL</b> including carrier panel (6 mm, 17 mm or 27 mm)   Item No.: 48742		<b>RISER</b> Item No.: 54327	<b>WALL COVERING</b> Item No.: 54301
<b>iDESIGN PARKETT®</b>	all species	<b>6,18</b>	<b>6,18</b>	<b>6,18</b>	<b>6,18</b>

Orders for prefab tread panels possible using the WP Multi measurement sheet.  
Templates for download from Weitzer Parkett Partner Portal.

<b>WOODEN STAIRS WP MULTI   EXTRAS</b>				
<b>Multi Front Edge (FE)</b> <b>PROFILE 40, 40 STYLE, BLOCK STYLE</b> Item No.: 40272   right/left   available on request without a tongue	350 mm   EURO/pc.	<b>10,51</b>	600 mm   EURO/pc.	<b>13,49</b>
<b>Multi Front Edge (FE)</b> <b>PROFILE 58 STYLE</b> Item No.: 40272   right/left   available on request without a tongue	350 mm   EURO/pc.	<b>11,54</b>	600 mm   EURO/pc.	<b>14,52</b>
<b>Multi Wall Cover Moulding (WCM)</b> <b>PROFILE 40, 40 STYLE, 58 STYLE BLOCK STYLE</b> Item No.: 40281   right/left, straight/L- and U-shaped	350 mm   EURO/pc.	<b>10,51</b>	650 mm   EURO/pc.	<b>19,47</b>
<b>Multi Front Edge - Riser (FER)</b> <b>PROFILE 40/58 STYLE</b> for riser	white   EURO/lm Item No.: 40463	<b>6,90</b>	Species   EURO/lm Item No.: 40279	<b>12,77</b>
<b>Multi Landing Wall Cover Moulding</b> Item No.: 40627	40 x 14 mm   EURO/lm		<b>15,35</b>	
<b>Multi Front Edge (FE) execute</b> for treads including material	Tread Panel + wall covering EURO/pc.		<b>23,18</b>	
<b>Edge Profile for Stairs 40 (LEP)</b> Item No.: 54295 Dimensions: 40 mm x 14 mm   curvature/radius: 3 mm Fixed length: 2500 mm	Colour range <b>LAVA/TERRA</b> EURO/lm	<b>20,19</b>	remaining colour scheme EURO/lm	<b>16,07</b>

Further extras and detailed descriptions from page 141!

WP Multi wooden stairs delivery time **Stock items**: 12 working days from order confirmation ex works. Stair edge profile delivery time **Stock items**: 7 working days from order confirmation ex works.WP Multi **iDESIGN PARKETT®** wooden staircase delivery time: 5-8 working weeks from order confirmation ex works. **iDESIGN PARKETT®** edge profile for stairs delivery time: 5-8 working weeks from order confirmation ex works.

## WP 4100

2-layer | Dimensions: 1000 x 125 x 11 mm | 1 Package = 1,50 m<sup>2</sup>



COLOUR RANGE					ITEM NO.	EUR/m <sup>2</sup>	EDGE PROFILE 40 FOR STEPS EUR/lm Item No. 29883
LAVA	FUMED OAK MELANGE						
	PVf	lively (original*)	bevelled	iDESIGN PARQUET*	42829	<b>93,22</b>	36,15
	PVf	lively (original*)	bevelled, brushed	iDESIGN PARQUET*	28844	<b>95,79</b>	36,56
	PVf	lively (original*)	bevelled, deep brushed	iDESIGN PARQUET*	40683	<b>97,85</b>	36,77
	PVf	lively (original*)	bevelled, intensely brushed	iDESIGN PARQUET*	50783	<b>108,15</b>	38,32
	PVf	lively (original*)	bevelled, scraped	iDESIGN PARQUET*	50784	<b>111,24</b>	38,73
LAVA	FUMED OAK						
	PA+	lively (original*)		STOCK ITEM	20608	<b>73,13</b>	33,27
	PVf	lively (original*)		STOCK ITEM	27677	<b>75,19</b>	33,58
	PVf	lively (original*)	bevelled	iDESIGN PARQUET*	27713	<b>83,43</b>	34,71
	PVf	lively (original*)	bevelled, brushed	iDESIGN PARQUET*	27714	<b>86,01</b>	35,12
	PVf	lively (original*)	bevelled, deep brushed	iDESIGN PARQUET*	42018	<b>88,07</b>	35,43
	PVf	lively (original*)	bevelled, intensely brushed	iDESIGN PARQUET*	53790	<b>98,37</b>	36,87
	PVf	lively (original*)	bevelled, scraped	iDESIGN PARQUET*	53791	<b>101,46</b>	37,29
TERRA	NUT STEAMED						
	PA+	lively colourful (structure)		STOCK ITEM	21167	<b>87,96</b>	36,77
	PVf	lively colourful (structure)		STOCK ITEM	27679	<b>90,02</b>	37,08
TERRA	OAK COFFEE						
	PA+	lively (original*)		STOCK ITEM	21157	<b>73,13</b>	33,27
	PVf	lively (original*)	bevelled	iDESIGN PARQUET*	50892	<b>83,43</b>	34,71
	PVf	lively (original*)	bevelled, brushed	iDESIGN PARQUET*	40337	<b>86,01</b>	35,12

\*no sapwood

SURCHARGE EDGE PROFILES	EUR/lm	SURCHARGE HERRINGBONE	EUR/m <sup>2</sup>
EDGE PROFILE 40 SYLE	+ 14,73	HERRINGBONE 90°	+ 4,12
EDGE PROFILE 58 SYLE	+ 16,79	FRENCH HERRINGBONE 60°/45°	+ 23,59
EDGE PROFILE BLOCK STYLE (riser is supplied loose)	+ 60,05	All items except bevelled in PS and PA+ suitable!	

All prices for WP Multi and Extras can be found on page 113

## WP 4100

2-layer | Dimensions: 1000 x 125 x 11 mm | 1 Package = 1,50 m<sup>2</sup>

COLOUR RANGE TERRA	OAK KROKANT			ITEM NO.	EUR/m <sup>2</sup>	EDGE PROFILE 40 FOR STEPS EUR/lm Item No. 29883
--------------------	-------------	--	--	----------	--------------------	---

	PVf	calm (Nature)	bevelled	iDESIGN PARQUET*	53833	72,62	32,86
	PVf	calm (Nature)	bevelled, brushed	iDESIGN PARQUET*	53834	75,19	33,27
	PVf	calm (Nature)	bevelled, deep brushed	iDESIGN PARQUET*	53835	77,25	33,58
	PVf	calm (Nature)	bevelled, scraped	iDESIGN PARQUET*	53837	90,64	35,43
	PVf	lively (accent)	bevelled	iDESIGN PARQUET*	42886	68,80	32,34
	PVf	lively (accent)	bevelled, brushed	iDESIGN PARQUET*	42887	71,38	32,65
	PVf	lively (accent)	bevelled, deep brushed	iDESIGN PARQUET*	42888	73,44	32,96
	PVf	lively (accent)	bevelled, intensely brushed	iDESIGN PARQUET*	51486	83,74	34,51
	PVf	lively (accent)	bevelled, scraped	iDESIGN PARQUET*	51522	86,83	34,92

COLOUR RANGE FIRE	ROBINIA STEAMED			ITEM NO.	EUR/m <sup>2</sup>	EDGE PROFILE 40 FOR STEPS EUR/lm Item No. 29883
-------------------	-----------------	--	--	----------	--------------------	---

	PA+	lively colourful (original)		STOCK ITEM	20612	74,78	33,48
	PVf	lively colourful (original)		STOCK ITEM	27681	76,84	33,78

COLOUR RANGE NATURE	OAK MANDEL			ITEM NO.	EUR/m <sup>2</sup>	EDGE PROFILE 40 FOR STEPS EUR/lm Item No. 29883
---------------------	------------	--	--	----------	--------------------	---

	PVf	calm (Nature)	bevelled	iDESIGN PARQUET*	53853	72,62	32,86
	PVf	calm (Nature)	bevelled, brushed	iDESIGN PARQUET*	53854	75,19	33,27
	PVf	calm (Nature)	bevelled, deep brushed	iDESIGN PARQUET*	53855	77,25	33,58
	PVf	calm (Nature)	bevelled, scraped	iDESIGN PARQUET*	53857	90,64	35,43
	PVf	lively (accent)	bevelled	iDESIGN PARQUET*	27830	68,80	32,34
	PVf	lively (accent)	bevelled, brushed	iDESIGN PARQUET*	27831	71,38	32,65
	PVf	lively (accent)	bevelled, deep brushed	iDESIGN PARQUET*	43324	73,44	32,96
	PVf	lively (accent)	bevelled, intensely brushed	iDESIGN PARQUET*	51770	83,74	34,51
	PVf	lively (accent)	bevelled, scraped	iDESIGN PARQUET*	51808	86,83	34,92

SURCHARGE EDGE PROFILES	EUR/lm	SURCHARGE HERRINGBONE	EUR/m <sup>2</sup>
EDGE PROFILE 40 SYLE	+ 14,73	HERRINGBONE 90°	+ 4,12
EDGE PROFILE 58 SYLE	+ 16,79	FRENCH HERRINGBONE 60°/45°	+ 23,59
EDGE PROFILE BLOCK STYLE (riser is supplied loose)	+ 60,05	All items except bevelled in PS and PA+ suitable!	

All prices for WP Multi and Extras can be found on page 113



## WP 4100

2-layer | Dimensions: 1000 x 125 x 11 mm | 1 Package = 1,50 m<sup>2</sup>



COLOUR RANGE NATURE		OAK		ITEM NO.	EUR/m <sup>2</sup>	EDGE PROFILE 40 FOR STEPS EUR/m Item No. 29883	
	PS	calm (Nature)		<b>STOCK ITEM</b>	49638	56,65	27,50
	PA+	calm (Nature)		<b>STOCK ITEM</b>	49637	56,65	27,50
	PVf	calm (Nature)		<b>STOCK ITEM</b>	49691	58,71	27,81
	PVf	calm (Nature)	bevelled	iDESIGN PARQUET*	53795	66,95	28,94
	PVf	calm (Nature)	bevelled, brushed	iDESIGN PARQUET*	53796	69,53	29,36
	PVf	calm (Nature)	bevelled, deep brushed	iDESIGN PARQUET*	53801	71,59	29,66
	PVf	calm (Nature)	bevelled, scraped	iDESIGN PARQUET*	53793	84,98	31,52
	PS	lively (accent)		<b>STOCK ITEM</b>	18338	52,84	26,99
	PA+	lively (accent)		<b>STOCK ITEM</b>	18591	52,84	26,99
	PA+	lively (accent)	brushed	<b>STOCK ITEM</b>	27686	55,41	27,30
	PVf	lively (accent)		<b>STOCK ITEM</b>	27685	54,90	27,19
	PVf	lively (accent)	brushed	<b>STOCK ITEM</b>	27687	57,47	27,60
	PVf	lively (accent)	bevelled	iDESIGN PARQUET*	27717	63,14	28,43
	PVf	lively (accent)	bevelled, brushed	iDESIGN PARQUET*	27718	65,71	28,84
	PVf	lively (accent)	bevelled, deep brushed	iDESIGN PARQUET*	42022	67,77	29,05
	PVf	lively (accent)	bevelled, intensely brushed	iDESIGN PARQUET*	51918	78,07	30,59
	PVf	lively (accent)	bevelled, scraped	iDESIGN PARQUET*	51949	81,16	31,00

COLOUR RANGE NATURE		OAK PURE		ITEM NO.	EUR/m <sup>2</sup>	EDGE PROFILE 40 FOR STEPS EUR/m Item No. 29883	
	PVf	calm (Nature)	bevelled	iDESIGN PARQUET*	53864	72,62	32,86
	PVf	calm (Nature)	bevelled, brushed	iDESIGN PARQUET*	49693	75,19	33,27
	PVf	calm (Nature)	bevelled, deep brushed	iDESIGN PARQUET*	53865	77,25	33,58
	PVf	calm (Nature)	bevelled, scraped	iDESIGN PARQUET*	53867	90,64	35,43
	PVf	lively (accent)	bevelled	iDESIGN PARQUET*	53863	68,80	32,34
	PVf	lively (accent)	bevelled, brushed	iDESIGN PARQUET*	52026	71,38	32,65
	PVf	lively (accent)	bevelled, deep brushed	iDESIGN PARQUET*	52229	73,44	32,96
	PVf	lively (accent)	bevelled, intensely brushed	iDESIGN PARQUET*	52110	83,74	34,51
	PVf	lively (accent)	bevelled, scraped	iDESIGN PARQUET*	52149	86,83	34,92

SURCHARGE EDGE PROFILES	EUR/m	SURCHARGE HERRINGBONE	EUR/m <sup>2</sup>
EDGE PROFILE 40 SYLE	+ 14,73	HERRINGBONE 90°	+ 4,12
EDGE PROFILE 58 SYLE	+ 16,79	FRENCH HERRINGBONE 60°/45°	+ 23,59
EDGE PROFILE BLOCK STYLE (riser is supplied loose)	+ 60,05	All items except bevelled in PS and PA+ suitable!	

All prices for WP Multi and Extras can be found on page 113

Stock item delivery time: promptly ex works (from 200 m<sup>2</sup> on request) | iDesign Parkett delivery time (from 20 m<sup>2</sup> per item): three to max. four weeks ex works (A flat LP surcharge of 400 EUR is billed under 20 m<sup>2</sup>.)  
All deliveries are based on the General Terms and Conditions of Business of Weitzer Parkett. All rights reserved for changes, composition and printing errors.



## WP 4100

2-layer | Dimensions: 1000 x 125 x 11 mm | 1 Package = 1,50 m<sup>2</sup>

COLOUR RANGE STONE				ITEM NO.	EUR/m <sup>2</sup>	EDGE PROFILE 40 FOR STEPS EUR/m Item No. 29883	
<b>OAK AUSTER</b>							
	PvF	calm (Nature)	bevelled	iDESIGN PARQUET*	53873	72,62	32,86
	PvF	calm (Nature)	bevelled, brushed	iDESIGN PARQUET*	53874	75,19	33,27
	PvF	calm (Nature)	bevelled, deep brushed	iDESIGN PARQUET*	53875	77,25	33,58
	PvF	calm (Nature)	bevelled, scraped	iDESIGN PARQUET*	53877	90,64	35,43
	PvF	lively (accent)	bevelled	iDESIGN PARQUET*	27851	68,80	32,34
	PvF	lively (accent)	bevelled, brushed	iDESIGN PARQUET*	27853	71,38	32,65
	PvF	lively (accent)	bevelled, deep brushed	iDESIGN PARQUET*	43682	73,44	32,96
	PvF	lively (accent)	bevelled, intensely brushed	iDESIGN PARQUET*	52299	83,74	34,51
	PvF	lively (accent)	bevelled, scraped	iDESIGN PARQUET*	52333	86,83	34,92
<b>OAK KASCHMIR</b>							
	PA+	calm (Nature)		STOCK ITEM	58717	60,77	31,21
	PvF	calm (Nature)		STOCK ITEM	50055	64,38	31,72
	PvF	calm (Nature)	bevelled	iDESIGN PARQUET*	53883	72,62	32,86
	PvF	calm (Nature)	bevelled, brushed	iDESIGN PARQUET*	53884	75,19	33,27
	PvF	calm (Nature)	bevelled, deep brushed	iDESIGN PARQUET*	53885	77,25	33,58
	PvF	calm (Nature)	bevelled, scraped	iDESIGN PARQUET*	53887	90,64	35,43
	PvF	lively (accent)	bevelled	iDESIGN PARQUET*	27842	68,80	32,34
	PvF	lively (accent)	bevelled, brushed	iDESIGN PARQUET*	27843	71,38	32,65
	PvF	lively (accent)	bevelled, deep brushed	iDESIGN PARQUET*	43831	73,44	32,96
	PvF	lively (accent)	bevelled, intensely brushed	iDESIGN PARQUET*	52421	83,74	34,51
	PvF	lively (accent)	bevelled, scraped	iDESIGN PARQUET*	52459	86,83	34,92
	PA+	lively colourful (spectrum)		STOCK ITEM	58718	53,15	30,08
<b>OAK ICE</b>							
	PvF	calm (Nature)	bevelled, deep brushed	iDESIGN PARQUET*	53893	81,37	34,09
	PvF	calm (Nature)	bevelled, scraped	iDESIGN PARQUET*	53894	94,76	36,05

## SURCHARGE EDGE PROFILES

EUR/m

EDGE PROFILE 40 SYLE

+ 14,73

EDGE PROFILE 58 SYLE

+ 16,79

EDGE PROFILE BLOCK STYLE (riser is supplied loose)

+ 60,05

## SURCHARGE HERRINGBONE

EUR/m<sup>2</sup>

HERRINGBONE 90°

+ 4,12

FRENCH HERRINGBONE 60°/45°

+ 23,59

All items except bevelled in PS and PA+ suitable!

All prices for WP Multi and Extras can be found on page 113



Stock item delivery time: promptly ex works (from 200 m<sup>2</sup> on request) | iDesign Parkett delivery time (from 20 m<sup>2</sup> per item): three to max. four weeks ex works (A flat LP surcharge of 400 EUR is billed under 20 m<sup>2</sup>). All deliveries are based on the General Terms and Conditions of Business of Weitzer Parkett. All rights reserved for changes, composition and printing errors.

## WP 4100

2-layer | Dimensions: 1000 x 125 x 11 mm | 1 Package = 1,50 m<sup>2</sup>



COLOUR RANGE	STONE			ITEM NO.	EUR/m <sup>2</sup>	EDGE PROFILE 40 FOR STEPS EUR/lm Item No. 29883
		<b>OAK ICE</b>				

	PvF	lively (accent)	bevelled, deep brushed	iDESIGN PARQUET*	29085	<b>77,56</b>	33,58
	PvF	lively (accent)	bevelled, intensely brushed	iDESIGN PARQUET*	53758	<b>87,86</b>	35,02
	PvF	lively (accent)	bevelled, scraped	iDESIGN PARQUET*	53739	<b>90,95</b>	35,54

COLOUR RANGE	STONE			ITEM NO.	EUR/m <sup>2</sup>	EDGE PROFILE 40 FOR STEPS EUR/lm Item No. 29883
		<b>OAK SAVANNE</b>				

	PvF	calm (Nature)	bevelled	iDESIGN PARQUET*	53900	<b>72,62</b>	32,86
	PvF	calm (Nature)	bevelled, brushed	iDESIGN PARQUET*	53901	<b>75,19</b>	33,27
	PvF	calm (Nature)	bevelled, deep brushed	iDESIGN PARQUET*	53902	<b>77,25</b>	33,58
	PvF	calm (Nature)	bevelled, scraped	iDESIGN PARQUET*	53904	<b>90,64</b>	35,43

	PvF	lively (accent)	bevelled	iDESIGN PARQUET*	53899	<b>68,80</b>	32,34
	PvF	lively (accent)	bevelled, brushed	iDESIGN PARQUET*	52537	<b>71,38</b>	32,65
	PvF	lively (accent)	bevelled, deep brushed	iDESIGN PARQUET*	52769	<b>73,44</b>	32,96
	PvF	lively (accent)	bevelled, intensely brushed	iDESIGN PARQUET*	52656	<b>83,74</b>	34,51
	PvF	lively (accent)	bevelled, scraped	iDESIGN PARQUET*	52690	<b>86,83</b>	34,92

COLOUR RANGE	STONE			ITEM NO.	EUR/m <sup>2</sup>	EDGE PROFILE 40 FOR STEPS EUR/lm Item No. 29883
		<b>OAK POLAR</b>				

	PvF	calm (Nature)	bevelled	iDESIGN PARQUET*	53910	<b>76,74</b>	33,48
	PvF	calm (Nature)	bevelled, brushed	iDESIGN PARQUET*	53911	<b>79,31</b>	33,89
	PvF	calm (Nature)	bevelled, deep brushed	iDESIGN PARQUET*	53912	<b>81,37</b>	34,09
	PvF	calm (Nature)	bevelled, scraped	iDESIGN PARQUET*	53914	<b>94,76</b>	36,05

	PvF	lively (accent)	bevelled	iDESIGN PARQUET*	52848	<b>72,92</b>	32,96
	PvF	lively (accent)	bevelled, brushed	iDESIGN PARQUET*	44032	<b>75,50</b>	33,27
	PvF	lively (accent)	bevelled, deep brushed	iDESIGN PARQUET*	53015	<b>77,56</b>	33,58
	PvF	lively (accent)	bevelled, intensely brushed	iDESIGN PARQUET*	52898	<b>87,86</b>	35,02
	PvF	lively (accent)	bevelled, scraped	iDESIGN PARQUET*	52938	<b>90,95</b>	35,54

SURCHARGE EDGE PROFILES	EUR/lm	SURCHARGE HERRINGBONE	EUR/m <sup>2</sup>
EDGE PROFILE 40 SYLE	+ 14,73	HERRINGBONE 90°	+ 4,12
EDGE PROFILE 58 SYLE	+ 16,79	FRENCH HERRINGBONE 60°/45°	+ 23,59
EDGE PROFILE BLOCK STYLE (riser is supplied loose)	+ 60,05	All items except bevelled in PS and PA+ suitable!	
All prices for WP Multi and Extras can be found on page 113			

## WP 4100

2-layer | Dimensions: 1000 x 125 x 11 mm | 1 Package = 1,50 m<sup>2</sup>

COLOUR RANGE STONE				ITEM NO.	EUR/m <sup>2</sup>	EDGE PROFILE 40 FOR STEPS EUR/lm Item No. 29883																	
	PVf	calm (Nature)	bevelled	iDESIGN PARQUET*	63826	76,74	33,48																
	PVf	calm (Nature)	bevelled, brushed	iDESIGN PARQUET*	63818	79,31	33,89																
	PVf	calm (Nature)	bevelled, deep brushed	iDESIGN PARQUET*	63827	81,37	34,09																
	PVf	calm (Nature)	bevelled, scraped	iDESIGN PARQUET*	53924	94,76	36,05																
	PVf	lively (accent)	bevelled	iDESIGN PARQUET*	63802	72,92	32,96																
	PVf	lively (accent)	bevelled, brushed	iDESIGN PARQUET*	63794	75,50	33,27																
	PVf	lively (accent)	bevelled, deep brushed	iDESIGN PARQUET*	63804	77,56	33,58																
	PVf	lively (accent)	bevelled, intensely brushed	iDESIGN PARQUET*	63805	87,86	35,02																
	PVf	lively (accent)	bevelled, scraped	iDESIGN PARQUET*	53433	90,95	35,54																
	PVf	lively colourful (spectrum)	bevelled, deep brushed	STOCK ITEM	62264	67,57	32,14																
	PVf	calm (Nature)	bevelled	iDESIGN PARQUET*	53970	72,62	32,86																
	PVf	calm (Nature)	bevelled, brushed	iDESIGN PARQUET*	53971	75,19	33,27																
	PVf	calm (Nature)	bevelled, deep brushed	iDESIGN PARQUET*	53972	77,25	33,58																
	PVf	calm (Nature)	bevelled, scraped	iDESIGN PARQUET*	53974	90,64	35,43																
	PVf	lively (accent)	bevelled	iDESIGN PARQUET*	53093	68,80	32,34																
	PVf	lively (accent)	bevelled, brushed	iDESIGN PARQUET*	44124	71,38	32,65																
	PVf	lively (accent)	bevelled, deep brushed	iDESIGN PARQUET*	53277	73,44	32,96																
	PVf	lively (accent)	bevelled, intensely brushed	iDESIGN PARQUET*	53159	83,74	34,51																
	PVf	lively (accent)	bevelled, scraped	iDESIGN PARQUET*	53198	86,83	34,92																
	<table border="1"> <thead> <tr> <th>SURCHARGE EDGE PROFILES</th> <th>EUR/lm</th> <th>SURCHARGE HERRINGBONE</th> <th>EUR/m<sup>2</sup></th> </tr> </thead> <tbody> <tr> <td>EDGE PROFILE 40 SYLE</td> <td>+ 14,73</td> <td>HERRINGBONE 90°</td> <td>+ 4,12</td> </tr> <tr> <td>EDGE PROFILE 58 SYLE</td> <td>+ 16,79</td> <td>FRENCH HERRINGBONE 60°/45°</td> <td>+ 23,59</td> </tr> <tr> <td>EDGE PROFILE BLOCK STYLE (riser is supplied loose)</td> <td>+ 60,05</td> <td colspan="2">All items except bevelled in PS and PA+ suitable!</td> </tr> </tbody> </table>							SURCHARGE EDGE PROFILES	EUR/lm	SURCHARGE HERRINGBONE	EUR/m <sup>2</sup>	EDGE PROFILE 40 SYLE	+ 14,73	HERRINGBONE 90°	+ 4,12	EDGE PROFILE 58 SYLE	+ 16,79	FRENCH HERRINGBONE 60°/45°	+ 23,59	EDGE PROFILE BLOCK STYLE (riser is supplied loose)	+ 60,05	All items except bevelled in PS and PA+ suitable!	
	SURCHARGE EDGE PROFILES	EUR/lm	SURCHARGE HERRINGBONE	EUR/m <sup>2</sup>																			
	EDGE PROFILE 40 SYLE	+ 14,73	HERRINGBONE 90°	+ 4,12																			
	EDGE PROFILE 58 SYLE	+ 16,79	FRENCH HERRINGBONE 60°/45°	+ 23,59																			
	EDGE PROFILE BLOCK STYLE (riser is supplied loose)	+ 60,05	All items except bevelled in PS and PA+ suitable!																				

All prices for WP Multi and Extras can be found on page 113



**Stock item delivery time:** promptly ex works (from 200 m<sup>2</sup> on request) | **iDesign Parkett delivery time (from 20 m<sup>2</sup> per item):** three to max. four weeks ex works (A flat LP surcharge of 400 EUR is billed to the customer). All deliveries are based on the General Terms and Conditions of Business of Weitzer Parkett. All rights reserved for changes, composition and printing errors.



## WP 4100 WOODEN STAIRS WP MULTI

Prices apply for all colours, surface finishes, grades, and additional treatments.

PROFILE 40	SPECIES	TREAD PANEL including carrier panel (6 mm, 17 mm or 27 mm)   Item No.: 29865		RISER Item No.: 54274	WALL COVERING Item No.: 54297
		EURO/ STEPS/linear meters straight	EURO/ STEPS/linear meters L- and U-SHAPED	EURO/ STEPS/linear meters	EURO/ linear meters
	Fumed Oak	107,12	125,87	54,38	85,49
	Nut steamed	128,34	150,79	65,10	102,18
	Oak Coffee	107,12	125,87	54,38	85,49
	Robinia steamed	107,33	126,07	54,59	85,70
	Oak	98,06	115,26	49,75	78,28
	White (RAL 9010)	-	-	21,22	-
SURCHARGE					
PROFILE 40 STYLE		14,73	14,73	-	-
PROFILE 58 STYLE		16,79	16,79	-	-
PROFILE BLOCK STYLE		60,05	60,05	Riser is included in the price and is supplied loose.	-
Customization Only possible with digital measuring system or stencils/moulds		14,63	17,41	15,96	Is customized
Riser pre-drilled, including screws Minimum thickness 19 mm		-	-	13,70	-
SURCHARGE					
		TREAD PANEL including carrier panel (6 mm, 17 mm or 27 mm)   Item No.: 48740		RISER Item No.: 54326	WALL COVERING Item No.: 54299
iDESIGN PARKETT®	all species	6,18	6,18	6,18	6,18





Orders for prefab tread panels possible using the WP Multi measurement sheet.  
Templates for download from Weitzer Parkett Partner Portal.

WOODEN STAIRS WP MULTI   EXTRAS					
Multi Front Edge (FE) PROFILE 40, 40 STYLE, BLOCK STYLE Item No.: 40272   right/left   available on request without a tongue	350 mm   EURO/pc.	10,51	600 mm   EURO/pc.	13,49	
Multi Front Edge (FE) PROFILE 58 STYLE Item No.: 40272   right/left   available on request without a tongue	350 mm   EURO/pc.	11,54	600 mm   EURO/pc.	14,52	
Multi Wall Cover Moulding (WCM) PROFILE 40, 40 STYLE, 58 STYLE BLOCK STYLE Item No.: 40281   right/left, straight/L- and U-shaped	350 mm   EURO/pc.	10,51	650 mm   EURO/pc.	19,47	
Multi Front Edge - Riser (FER) PROFILE 40/58 STYLE for riser Item No.: 40463	white   EURO/lm	6,90	Species   EURO/lm Item No.: 40279	12,77	
Multi Landing Wall Cover Moulding Item No.: 40627	40 x 14 mm   EURO/lm		15,35		
Multi Front Edge (FE) execute for treads including material	Tread Panel + wall covering EURO/pc.		23,18		
Edge Profile for Stairs 40 (LEP) Item No.: 54295 Dimensions: 40 mm x 14 mm   curvature/radius: 3 mm Fixed length: 2500 mm	Colour range LAVA/TERRA EURO/lm	20,19	remaining colour scheme EURO/lm	16,07	

Further extras and detailed descriptions from page 141!

## WP CHARISMA 2-STRIP

3-layer | Dimensions: 2245 x 193 x 14 mm | 1 Package = 2,60 m<sup>2</sup>

COLOUR RANGE	ITEM NO.	EUR/m <sup>2</sup>	EDGE PROFILE 40 FOR STEPS EUR/lm Item No. 29890
COLOUR RANGE LAVA  FUMED OAK ICE PA+ lively (original*)	16093	82,50	41,82
COLOUR RANGE TERRA  NUT STEAMED PS lively colourful (original)	15581	102,90	47,69
COLOUR RANGE MATURE  OAK PA+ lively (original*)	18207	53,97	32,03
COLOUR RANGE STONE  OAK KASCHMIR PA+ lively (original*)	18179	58,09	36,05
COLOUR RANGE STONE  ASH POLAR PA+ lively colourful (natural)	16087	50,78	34,61

WP PLANK SWITCH	WP Charisma 2-Strip in all colours, gradings and surfaces	60864	116,39
-----------------	---	-------	--------

SURCHARGE EDGE PROFILES	EUR/lm
EDGE PROFILE 40 SYLE	+ 3,60
EDGE PROFILE 58 SYLE	+ 5,67
EDGE PROFILE BLOCK SYLE (riser is supplied loose)	+ 46,35

All prices for WP Multi and Extras can be found on page 115

\*no sapwood



**Stock item delivery time:** promptly ex works (from 200 m<sup>2</sup> on request) | **iDesign Parkett delivery time (from 20 m<sup>2</sup> per item):** three to max. four weeks ex works (A flat LP surcharge of 400 EUR is billed under 20 m<sup>2</sup>.)  
 All deliveries are based on the General Terms and Conditions of Business of Weitzer Parkett. All rights reserved for changes, composition and printing errors.



## WP CHARISMA 2-STRIP WOODEN STAIRS WP MULTI

Prices apply for all colours, surface finishes, grades, and additional treatments.

PROFILE 40	SPECIES	TREAD PANEL without Carrier panel   Item No.: 29872		RISER Item No.: 54273	WALL COVERING Item No.: 54308
		EURO/ STEPS/linear meters straight	EURO/ STEPS/linear meters L- and U-SHAPED	EURO/ STEPS/linear meters	EURO/ linear meters
	Fumed Oak	<b>82,19</b>	<b>96,61</b>	<b>41,61</b>	<b>65,61</b>
	Nut steamed	<b>101,25</b>	<b>118,97</b>	<b>51,40</b>	<b>80,34</b>
	Oak	<b>71,17</b>	<b>83,64</b>	<b>36,05</b>	<b>56,75</b>
	Ash	<b>71,17</b>	<b>83,64</b>	<b>36,05</b>	<b>56,75</b>
	White (RAL 9010)	-	-	<b>21,22</b>	-
SURCHARGE					
PROFILE 40 STYLE		<b>10,30</b>	<b>10,30</b>	-	-
PROFILE 58 STYLE		<b>12,36</b>	<b>12,36</b>	-	-
PROFILE BLOCK STYLE		<b>46,35</b>	<b>46,35</b>	Riser is included in the price and is supplied loose.	-
Carrier panel 6 mm, 17 mm or 27 mm		<b>15,04</b>	<b>15,04</b>	<b>9,17</b>	<b>9,17</b>
Customization Only possible with digital measuring system or stencils/moulds		<b>14,63</b>	<b>17,41</b>	<b>15,96</b>	Is customized
Riser pre-drilled, including screws Minimum thickness 19 mm		-	-	<b>13,70</b>	-

Orders for prefab tread panels possible using the WP Multi measurement sheet.  
Templates for download from Weitzer Parkett Partner Portal.

WOODEN STAIRS WP MULTI   EXTRAS				
Multi Front Edge (FE) PROFILE 40, 40 STYLE, BLOCK STYLE Item No.: 40272   right/left   available on request without a tongue	350 mm   EURO/pc.	<b>10,51</b>	600 mm   EURO/pc.	<b>13,49</b>
Multi Front Edge (FE) PROFILE 58 STYLE Item No.: 40272   right/left   available on request without a tongue	350 mm   EURO/pc.	<b>11,54</b>	600 mm   EURO/pc.	<b>14,52</b>
Multi Wall Cover Moulding (WCM) PROFILE 40, 40 STYLE, 58 STYLE BLOCK STYLE Item No.: 40281   right/left, straight/L- and U-shaped	350 mm   EURO/pc.	<b>10,51</b>	650 mm   EURO/pc.	<b>19,47</b>
Multi Front Edge - Riser (FER) PROFILE 40/58 STYLE for riser	white   EURO/lm Item No.: 40463	<b>6,90</b>	Species   EURO/lm Item No.: 40279	<b>12,77</b>
Multi Landing Wall Cover Moulding Item No.: 40627	40 x 14 mm   EURO/lm		<b>15,35</b>	
Multi Front Edge (FE) execute for treads including material	Tread Panel + wall covering EURO/pc.		<b>23,18</b>	
Edge Profile for Stairs 40 (LEP) Item No.: 54295 Dimensions: 40 mm x 14 mm   curvature/radius: 3 mm Fixed length: 2500 mm	Colour range LAVA/TERRA EURO/lm	<b>20,19</b>	remaining colour scheme EURO/lm	<b>16,07</b>

Further extras and detailed descriptions from page 141!





# BLOCK APPEARANCE

## CREATES MORE LATITUDE

A PARQUET THAT MATCHES ANY STYLE: THE BLOCK APPEARANCE IS A TIMELESS CLASSICAL DESIGN. THANKS TO ITS DIVERSITY, BLOCK PARQUET GOES WELL WITH ANY STYLE OF FURNISHING.



BLOCK APPEARANCE | FUMED OAK | LIVELY (ORIGINAL\*)

\*no sapwood

## WP 475

## 2-LAYER PARQUET



- Herringbone and French Herringbone installation possible
- Single strip appearance with bevel on the longitudinal and header joints **(01)**
- Tongue and groove joint on four sides **(02)**
- Certified plywood bottom layer **(03)**
- Suitable for floating installation (except French Herringbone) or complete adhesion to the subfloor
- Ideally suited to underfloor heating



## DIMENSIONS:

750 x 125 x 12,2 mm

Overall thickness 12,2 mm with 3,6 mm wear layer

0 cm 100 cm 200 cm 300 cm 350 cm

## HERRINGBONE

UNIT	PACKAGE	PALETT
CONTENTS	20 boards = 1,87 m <sup>2</sup>	32 packages = 59,84 m <sup>2</sup>
DIMENSIONS	0,765 x 0,27 x 0,13 m	1,20 x 0,80 x 1,23 m
WEIGHT	approx. 18 kg	approx. 576 kg

## FRENCH HERRINGBONE 45°

UNIT	PACKAGE	PALETT
CONTENTS	20 boards = 1,55 m <sup>2</sup>	32 packages = 49,60 m <sup>2</sup>
DIMENSIONS	0,79 x 0,27 x 0,13 m	1,20 x 0,80 x 1,23 m
WEIGHT	approx. 15 kg	approx. 480 kg

## FRENCH HERRINGBONE 60°

UNIT	PAKET	PALETT
CONTENTS	20 boards = 1,68 m <sup>2</sup>	32 packages = 53,76 m <sup>2</sup>
DIMENSIONS	0,79 x 0,27 x 0,13 m	1,20 x 0,80 x 1,23 m
WEIGHT	approx. 16 kg	approx. 520 kg



## WP 450

### 2-LAYER PARQUET



- Available in an extremely wide choice of wood species, finishes and surfaces
- Tongue and groove joint on four sides **(01)**
- Tailor-made and dimensionally stable header joint by utilizing top-quality plywood **(02)**
- Spruce supporting material with vertically arranged growth rings **(03)**
- Offers the greatest freedom of choice of installation patterns, also perfect for combining with WP 4100



#### Herringbone and French Herringbone\* installation:

- All articles in all surfaces are suitable for Herringbone installation
  - Joint-edge impregnation is recommended
- For French Herringbone installation:
  - Inquiry possible for 60° and 45° laying

\* from an order of 20 m<sup>2</sup>

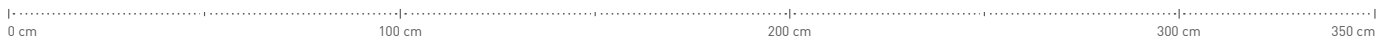

#### DIMENSIONS:

500 x 65 x 11 mm  
Overall thickness 11 mm with approx. 3,6 mm wear layer

#### PACKING UNITS

UNIT	PACKAGE	PALLET
CONTENTS	72 boards = 2,34 m <sup>2</sup> <small>(each package contains 50% right and 50% left blocks)</small>	30 packages = 70,20 m <sup>2</sup>
DIMENSIONS	0,51 x 0,28 x 0,205 m	1,20 x 0,80 x 1,18 m
WEIGHT	approx. 14,29 kg	approx. 428,70 kg
EDGE PROFILE FOR STEPS	Fixed length: 1 m, 1,5 m or 2 m; Profile 40, 40 style, 58 style and Block style; Profile Block style: riser is delivered loose	

#### PACKING UNITS FRENCH HERRINGBONE

**French Herringbone 45°** = 2,04 m<sup>2</sup> per unit  
**French Herringbone 60°** = 2,15 m<sup>2</sup> per unit

## WP CHARISMA 3-STRIP

## 3-LAYER PARQUET



- Intelligent patented double-click system with the greatest interlocking power on the market. **(01)**
- Patented press-stud principle for simultaneous locking of the longitudinal and header joints in one movement **(02)**:
  - Fast and simple one-man assembly and disassembly
  - Can be completely adhered to the subfloor\*
- Header joint edge locking mechanism made from solid hardwood only - completely free from plastic components and plasticizers **(03)**
- Spruce supporting material with vertically arranged growth rings **(04)**
- HydroStop:
  - Unique all-round joint-edge impregnation
  - Provides the ultimate protection against the ingress of moisture due to small spillages
- **NOW NEW:** The WP rotatable plank allows a simple modification of the laying direction

\* Ideally suited to underfloor heating, as it can be completely adhered to the subfloor

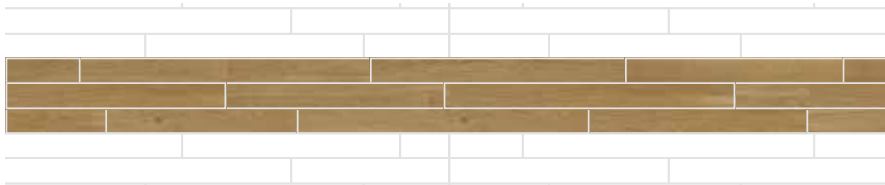
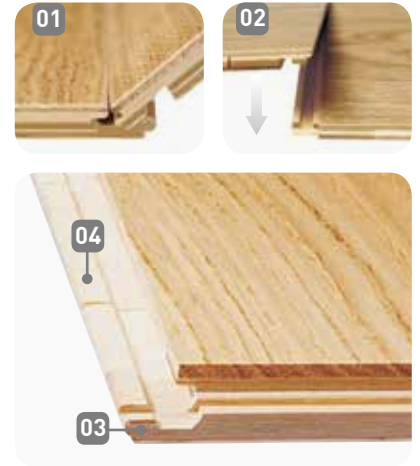

## DIMENSIONS:

2245 x 193 x 14 mm

Overall thickness 14 mm with approx. 3,6 mm wear layer

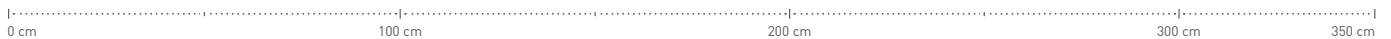

## PACKING UNITS

























UNIT	PACKAGE	PALLET
CONTENTS	6 boards = 2,60 m <sup>2</sup>	35 packages = 91,00 m <sup>2</sup>
DIMENSIONS	2,28 x 0,215 x 0,085 m	2,28 x 1,10 x 0,71 m
WEIGHT	approx. 19,80 kg	approx. 693 kg
EDGE PROFILE FOR STEPS	Fixed length: 2,245 m; Profile 40, 40 style, 58 style and Block style; Profile Block style: riser is delivered loose	





## COLOUR RANGE OVERVIEW

### STOCK ITEM

 <p>COLOUR RANGE <b>LAVA</b> <b>FUMED OAK</b> lively (original*) ▪ WP 450, WP Charisma 3-Strip</p>	 <p>COLOUR RANGE <b>TERRA</b> <b>NUT STEAMED</b> lively colourful (original) ▪ WP 450, WP Charisma 3-Strip</p>	 <p>COLOUR RANGE <b>TERRA</b> <b>OAK COFFEE</b> lively (original*) ▪ WP 450</p>	 <p>COLOUR RANGE <b>TERRA</b> <b>OAK HAVANA</b> lively colourful (structure) ▪ WP Charisma 3-Strip</p>	 <p>COLOUR RANGE <b>FIRE</b> <b>ROBINIA STEAMED</b> lively colourful (original) ▪ WP 450, WP Charisma 3-Strip</p>
 <p>COLOUR RANGE <b>FIRE</b> <b>CHERRY STEAMED</b> lively colourful (original) ▪ WP Charisma 3-Strip</p>	 <p>COLOUR RANGE <b>FIRE</b> <b>BEECH STEAMED</b> calm (nature) ▪ WP 450, WP Charisma 3-Strip</p>	 <p>COLOUR RANGE <b>FIRE</b> <b>BEECH STEAMED</b> lively colourful (structure) ▪ WP Charisma 3-Strip</p>	 <p>COLOUR RANGE <b>NATURE</b> <b>OAK MANDEL</b> lively colourful (spectrum) ▪ WP 475</p>	 <p>COLOUR RANGE <b>NATURE</b> <b>OAK</b> exquisit (exquisite) ▪ WP 450 WP Charisma 3-Strip</p>
 <p>COLOUR RANGE <b>NATURE</b> <b>OAK</b> calm (nature) ▪ WP 450 WP Charisma 3-Strip</p>	 <p>COLOUR RANGE <b>NATURE</b> <b>OAK</b> calm (select) ▪ WP 475</p>	 <p>COLOUR RANGE <b>NATURE</b> <b>OAK</b> lively (accent) ▪ WP 475</p>	 <p>COLOUR RANGE <b>NATURE</b> <b>OAK</b> lively (accent) ▪ WP 450</p>	 <p>COLOUR RANGE <b>NATURE</b> <b>OAK</b> lively colourful (structure) ▪ WP Charisma 3-Strip</p>
 <p>COLOUR RANGE <b>NATURE</b> <b>OAK</b> lively colourful (spectrum) ▪ WP 450</p>	 <p>COLOUR RANGE <b>NATURE</b> <b>OAK PURE</b> calm (nature) ▪ WP Charisma 3-Strip</p>	 <p>COLOUR RANGE <b>NATURE</b> <b>OAK PURE</b> lively (accent) ▪ WP 475</p>	 <p>COLOUR RANGE <b>STONE</b> <b>OAK AUSTER</b> calm (nature) ▪ WP 450, WP Charisma 3-Strip</p>	 <p>COLOUR RANGE <b>STONE</b> <b>OAK AUSTER</b> lively colourful (spectrum) ▪ WP 475</p>
 <p>COLOUR RANGE <b>STONE</b> <b>OAK KASCHMIR</b> calm (nature) ▪ WP 450, WP Charisma 3-Strip</p>	 <p>COLOUR RANGE <b>STONE</b> <b>OAK KASCHMIR</b> lively (accent) ▪ WP 475</p>	 <p>COLOUR RANGE <b>STONE</b> <b>OAK KASCHMIR</b> lively colourful (spectrum) ▪ WP 450</p>	 <p>COLOUR RANGE <b>STONE</b> <b>OAK SAVANNE</b> calm (nature) ▪ WP 450, WP Charisma 3-Strip</p>	 <p>COLOUR RANGE <b>STONE</b> <b>OAK COLORADO</b> <b>DIAMOND ICE</b> lively colourful (spectrum) ▪ WP 475</p>















Stock item delivery time: promptly ex works (from 200 m<sup>2</sup> on request)

All deliveries are based on the General Terms and Conditions of Business of Weitzer Parkett. All rights reserved for changes, composition and printing errors.



## COLOUR RANGE OVERVIEW

## STOCK ITEM

 <p>COLOUR RANGE <b>STONE</b> <b>ASH POLAR</b> calm (select)</p> <ul style="list-style-type: none"> <li>WP Charisma 3-Strip </li> </ul>	 <p>COLOUR RANGE <b>SAND</b> <b>ASH LATTE</b> calm (select)</p> <ul style="list-style-type: none"> <li>WP 450 </li> </ul>	 <p>COLOUR RANGE <b>SAND</b> <b>CANADIAN MAPLE</b> calm (nature)</p> <ul style="list-style-type: none"> <li>WP 450, WP Charisma 3-Strip </li> </ul>	 <p>COLOUR RANGE <b>SAND</b> <b>CANADIAN MAPLE</b> lively colourful (structure)</p> <ul style="list-style-type: none"> <li>WP 450, WP Charisma 3-Strip </li> </ul>	 <p>COLOUR RANGE <b>SAND</b> <b>ASH</b> calm (select)</p> <ul style="list-style-type: none"> <li>WP 450, WP Charisma 3-Strip </li> </ul>
 <p>COLOUR RANGE <b>SAND</b> <b>ASH</b> lively colourful (structure)</p> <ul style="list-style-type: none"> <li>WP 450, WP Charisma 3-Strip </li> </ul>				



The grading overview serves as a rough orientation. To obtain a representative grading picture please see our official grading book or get info from our partner portal:  
<https://partner.weitzer-parkett.com>



**Stock item delivery time:** promptly ex works (from 200 m<sup>2</sup> on request)

All deliveries are based on the General Terms and Conditions of Business of Weitzer Parkett. All rights reserved for changes, composition and printing errors.

## WP 475

2-layer | Dimensions: 750 x 125 x 12,2 mm  
1 Package = 1,87 m<sup>2</sup>

HERRING-  
BONE



COLOUR RANGE	NAME	FINISH	STATUS	ITEM NO.	EUR/m <sup>2</sup>	EDGE PROFILE 40 FOR STEPS EUR/m	
COLOUR RANGE NATURE	OAK MANDEL	PA+ lively colourful (spectrum)	bevelled, brushed	COLLECTION HB	63659	54,80	-
		PVf lively colourful (spectrum)	bevelled, brushed	MADE TO ORDER	63761	58,30	-
COLOUR RANGE NATURE	OAK	PA+ calm (select)	bevelled, brushed	COLLECTION HB	63655	58,00	-
		PVf calm (select)	bevelled, brushed	MADE TO ORDER	63758	60,00	-
		PA+ lively (accent)	bevelled, brushed	COLLECTION HB	63657	54,40	-
		PVf lively (accent)	bevelled, brushed	MADE TO ORDER	63759	56,40	-
COLOUR RANGE NATURE	OAK PURE	PA+ lively (accent)	bevelled, brushed	COLLECTION HB	63662	58,40	-
		PVf lively (accent)	bevelled, brushed	MADE TO ORDER	63763	61,90	-
COLOUR RANGE STONE	OAK AUSTER	PA+ lively colourful (spectrum)	bevelled, brushed	COLLECTION HB	63660	54,80	-
		PVf lively colourful (spectrum)	bevelled, brushed	MADE TO ORDER	63762	58,30	-
COLOUR RANGE STONE	OAK KASCHMIR	PA+ lively (accent)	bevelled, brushed	COLLECTION HB	63658	58,40	-
		PVf lively (accent)	bevelled, brushed	MADE TO ORDER	63760	61,90	-
COLOUR RANGE STONE	OAK COLORADO DIAMOND ICE	PA+ lively colourful (spectrum)	bevelled, brushed	COLLECTION HB	63661	61,80	-
		PVf lively colourful (spectrum)	bevelled, brushed	MADE TO ORDER	63764	62,30	-

## WP 475

2-layer | Dimensions: 750 x 125 x 12,2 mm  
1 Package = 1,55 m<sup>2</sup>FRENCH  
HERRING-  
BONE

45°

3,6



COLOUR RANGE				ITEM NO.	EUR/m <sup>2</sup>	EDGE PROFILE 40 FOR STEPS EUR/m
MATURE		<b>OAK MANDEL</b>				
PVf	lively colourful (spectrum)	bevelled, brushed	MADE TO ORDER	63768	81,20	-
MATURE		<b>OAK</b>				
PVf	calm (select)	bevelled, brushed	MADE TO ORDER	63765	82,90	-
PVf	lively (accent)	bevelled, brushed	MADE TO ORDER	63766	79,30	-
MATURE		<b>OAK PURE</b>				
PVf	lively (accent)	bevelled, brushed	MADE TO ORDER	63771	84,80	-
STONE		<b>OAK AUSTER</b>				
PVf	lively colourful (spectrum)	bevelled, brushed	MADE TO ORDER	63769	81,20	-
STONE		<b>OAK KASCHMIR</b>				
PVf	lively (accent)	bevelled, brushed	MADE TO ORDER	63767	84,80	-
STONE		<b>OAK COLORADO DIAMOND ICE</b>				
PVf	lively colourful (spectrum)	bevelled, brushed	MADE TO ORDER	63770	85,20	-



## WP 475

2-layer | Dimensions: 750 x 125 x 12,2 mm  
1 Package = 1,68 m<sup>2</sup>

FRENCH  
HERRING-  
BONE

60°

3,6



COLOUR RANGE	COLOUR RANGE				ITEM NO.	EUR/m <sup>2</sup>	EDGE PROFILE 40 FOR STEPS EUR/lm	
NATURE	OAK MANDEL							
		PVf	lively colourful (spectrum)	bevelled, brushed	MADE TO ORDER	63775	81,20	-
NATURE	OAK							
		PVf	calm (select)	bevelled, brushed	MADE TO ORDER	63772	82,90	-
		PVf	lively (accent)	bevelled, brushed	MADE TO ORDER	63773	79,30	-
NATURE	OAK PURE							
		PVf	lively (accent)	bevelled, brushed	MADE TO ORDER	63778	84,80	-
STONE	OAK AUSTER							
		PVf	lively colourful (spectrum)	bevelled, brushed	MADE TO ORDER	63776	81,20	-
STONE	OAK KASCHMIR							
		PVf	lively (accent)	bevelled, brushed	MADE TO ORDER	63774	84,80	-
STONE	OAK COLORADO DIAMOND ICE							
		PVf	lively colourful (spectrum)	bevelled, brushed	MADE TO ORDER	63777	85,20	-



## WP 450

2-layer | Dimensions: 500 x 65 x 11 mm | 1 Package = 2,34 m<sup>2</sup>

COLOUR RANGE	ITEM NO.	EUR/m <sup>2</sup>	EDGE PROFILE 40 FOR STEPS EUR/lm Item No. 29885
<b>LAVA</b>	<b>FUMED OAK</b>		
PS lively (original*)	<b>STOCK ITEM</b> 18425	<b>56,55</b>	31,21
PA+ lively (original*)	<b>STOCK ITEM</b> 18546	<b>56,55</b>	31,21
PVf lively (original*)	<b>STOCK ITEM</b> 27702	<b>58,61</b>	31,52
<b>TERIA</b>	<b>NUT STEAMED</b>		
PA+ lively colourful (original)	<b>STOCK ITEM</b> 59443	<b>77,66</b>	35,74
<b>TERIA</b>	<b>OAK COFFEE</b>		
PA+ lively (original*)	<b>STOCK ITEM</b> 21341	<b>56,55</b>	31,21
<b>FIRE</b>	<b>ROBINIA STEAMED</b>		
PS lively colourful (original)	<b>STOCK ITEM</b> 15927	<b>57,89</b>	31,41
PA+ lively colourful (original)	<b>STOCK ITEM</b> 18544	<b>57,89</b>	31,41
<b>FIRE</b>	<b>BEECH STEAMED</b>		
PS calm (Nature)	<b>STOCK ITEM</b> 15874	<b>41,82</b>	24,21
<b>NATURE</b>	<b>OAK</b>		
PS exquisite (exquisite)	<b>STOCK ITEM</b> 15838	<b>56,55</b>	27,81
PA+ exquisite (exquisite)	<b>STOCK ITEM</b> 18534	<b>56,55</b>	27,81
PVf exquisite (exquisite)	<b>STOCK ITEM</b> 27707	<b>58,61</b>	28,12

\*no sapwood

SURCHARGE EDGE PROFILES	EUR/lm	SURCHARGE HERRINGBONE	EUR/m <sup>2</sup>
<b>EDGE PROFILE 40 SYLE</b>	+ 11,85	<b>FRENCH HERRINGBONE 60°/45°</b>	+ 33,48
<b>EDGE PROFILE 58 SYLE</b>	+ 13,91		
<b>EDGE PROFILE BLOCK STYLE</b> (riser is supplied loose)	+ 54,49		
All prices for WP Multi and Extras can be found on page 130			

Stock item delivery time: promptly ex works (from 200 m<sup>2</sup> on request)

All deliveries are based on the General Terms and Conditions of Business of Weitzer Parkett. All rights reserved for changes, composition and printing errors.

## WP 450

2-layer | Dimensions: 500 x 65 x 11 mm | 1 Package = 2,34 m<sup>2</sup>



COLOUR RANGE	NAME	ITEM NO.	EUR/m <sup>2</sup>	EDGE PROFILE 40 FOR STEPS EUR/lm Item No. 29885
COLOUR RANGE NATURE	<b>OAK</b>			
	PS calm (Nature)	STOCK ITEM 18405	43,98	25,96
	PA+ calm (Nature)	STOCK ITEM 18536	43,98	25,96
	PVf calm (Nature)	STOCK ITEM 27708	46,04	26,27
	PS lively (accent)	STOCK ITEM 18406	40,99	25,44
	PA+ lively (accent)	STOCK ITEM 18537	40,99	25,44
	PVf lively (accent)	STOCK ITEM 27709	43,05	25,75
	PS lively colourful (spectrum)	STOCK ITEM 18449	38,11	25,03
	PA+ lively colourful (spectrum)	STOCK ITEM 18677	38,11	25,03
PVf lively colourful (spectrum)	STOCK ITEM 27710	40,17	25,34	
COLOUR RANGE STONE	<b>OAK AUSTER</b>			
	PA+ calm (Nature)	STOCK ITEM 27712	48,10	29,66
COLOUR RANGE STONE	<b>OAK KASCHMIR</b>			
	PA+ calm (Nature)	STOCK ITEM 58720	48,10	29,66
	PA+ lively colourful (spectrum)	STOCK ITEM 58723	42,23	28,74
COLOUR RANGE STONE	<b>OAK SAVANNE</b>			
	PA+ calm (Nature)	STOCK ITEM 22186	48,10	29,66
COLOUR RANGE SAND	<b>ASH LATTE</b>			
	PA+ calm (select)	STOCK ITEM 18539	54,59	30,80

SURCHARGE EDGE PROFILES	EUR/lm	SURCHARGE HERRINGBONE	EUR/m <sup>2</sup>
EDGE PROFILE 40 SYLE	+ 11,85	FRENCH HERRINGBONE 60°/45°	+ 33,48
EDGE PROFILE 58 SYLE	+ 13,91		
EDGE PROFILE BLOCK STYLE (riser is supplied loose)	+ 54,49		

All prices for WP Multi and Extras can be found on page 130





## WP 450

2-layer | Dimensions: 500 x 65 x 11 mm | 1 Package = 2,34 m<sup>2</sup>

COLOUR RANGE SAND			ITEM NO.	EUR/m <sup>2</sup>	EDGE PROFILE 40 FOR STEPS EUR/lm Item No. 29885	
	PS	calm (Nature)	<b>STOCK ITEM</b>	15912	60,67	30,59
	PS	lively colourful (structure)	<b>STOCK ITEM</b>	15913	52,53	29,36
	PS	calm (select)	<b>STOCK ITEM</b>	15860	46,87	26,57
	PS	lively colourful (structure)	<b>STOCK ITEM</b>	15861	35,54	24,82

## SURCHARGE EDGE PROFILES

EUR/lm

EDGE PROFILE 40 SYLE

+ 11,85

EDGE PROFILE 58 SYLE

+ 13,91

EDGE PROFILE BLOCK STYLE (riser is supplied loose)

+ 54,49

All prices for WP Multi and Extras can be found on page 130

## SURCHARGE HERRINGBONE

EUR/m<sup>2</sup>

FRENCH HERRINGBONE 60°/45°

+ 33,48

Stock item delivery time: promptly ex works (from 200 m<sup>2</sup> on request)

All deliveries are based on the General Terms and Conditions of Business of Weitzer Parkett. All rights reserved for changes, composition and printing errors.



## WP 450 WOODEN STAIRS WP MULTI

Prices apply for all colours, surface finishes, grades, and additional treatments.

PROFILE 40	SPECIES	TREAD PANEL including carrier panel (6 mm, 17 mm or 27 mm)   Item No.: 29869		RISER Item No.: 54276	WALL COVERING Item No.: 54302
		EURO/ STEPS/linear meters straight	EURO/ STEPS/linear meters L- and U-SHAPED	EURO/ STEPS/linear meters	EURO/ linear meters
	Fumed Oak	104,03	122,26	49,13	83,02
	Nut steamed	121,23	142,45	57,47	96,61
	Oak Coffee	104,03	122,26	49,13	83,02
	Robinia steamed	104,24	122,47	49,34	83,22
	Beech steamed	93,42	109,80	43,98	74,67
	Oak	93,83	110,21	44,19	74,88
	Ash	93,83	110,21	44,19	74,88
	Canadian Maple	103,82	121,95	49,13	83,02
	White (RAL 9010)	-	-	21,22	-
SURCHARGE					
PROFILE 40 STYLE		11,85	11,85	-	-
PROFILE 58 STYLE		13,91	13,91	Riser is included in the price and is supplied loose.	-
PROFILE BLOCK STYLE		54,49	54,08	Riser is included in the price and is supplied loose.	-
Customization Only possible with digital measuring system or stencils/moulds		14,63	17,41	15,96	Is customized
Riser pre-drilled, including screws Minimum thickness 19 mm		-	-	13,70	-















Orders for prefab tread panels possible using the WP Multi measurement sheet.  
Templates for download from Weitzer Parkett Partner Portal.

WOODEN STAIRS WP MULTI   EXTRAS					
Multi Front Edge (FE) PROFILE 40, 40 STYLE, BLOCK STYLE Item No.: 40272   right/left   available on request without a tongue	350 mm   EURO/pc.	10,51	600 mm   EURO/pc.	13,49	
Multi Front Edge (FE) PROFILE 58 STYLE Item No.: 40272   right/left   available on request without a tongue	350 mm   EURO/pc.	11,54	600 mm   EURO/pc.	14,52	
Multi Wall Cover Moulding (WCM) PROFILE 40, 40 STYLE, 58 STYLE BLOCK STYLE Item No.: 40281   right/left, straight/L- and U-shaped	350 mm   EURO/pc.	10,51	650 mm   EURO/pc.	19,47	
Multi Front Edge - Riser (FER) PROFILE 40/58 STYLE for riser Item No.: 40463	white   EURO/lm	6,90	Species   EURO/lm Item No.: 40279	12,77	
Multi Landing Wall Cover Moulding Item No.: 40627	40 x 14 mm   EURO/lm		15,35		
Multi Front Edge (FE) execute for treads including material	Tread Panel + wall covering EURO/pc.		23,18		
Edge Profile for Stairs 40 (LEP) Item No.: 54295 Dimensions: 40 mm x 14 mm   curvature/radius: 3 mm Fixed length: 2500 mm	Colour range LAVA/TERRA EURO/lm	20,19	remaining colour scheme EURO/lm	16,07	

Further extras and detailed descriptions from page 141!

## WP CHARISMA 3-STRIP

3-layer | Dimensions: 2245 x 193 x 14 mm | 1 Package = 2,60 m<sup>2</sup>

COLOUR RANGE	ITEM NO.	EUR/m <sup>2</sup>	EDGE PROFILE 40 FOR STEPS EUR/lm Item No. 29888
<b>COLOUR RANGE LANA</b> 	<b>FUMED OAK</b>		
 PA+ lively (original*)	<b>STOCK ITEM</b> 18216	<b>55,93</b>	35,95
<b>COLOUR RANGE TERRA</b> 	<b>NUT STEAMED</b>		
 PA+ lively colourful (original)	<b>STOCK ITEM</b> 18222	<b>83,84</b>	43,47
<b>COLOUR RANGE TERRA</b> 	<b>OAK HAVANA</b>		
 PA+ lively colourful (structure)	<b>STOCK ITEM</b> 28075	<b>41,72</b>	32,45
<b>COLOUR RANGE FIRE</b> 	<b>ROBINIA STEAMED</b>		
 PS lively colourful (original)	<b>STOCK ITEM</b> 15535	<b>57,17</b>	36,15
 PA+ lively colourful (original)	<b>STOCK ITEM</b> 18210	<b>57,17</b>	36,15
<b>COLOUR RANGE FIRE</b> 	<b>CHERRY STEAMED</b>		
 PA+ lively colourful (original)	<b>STOCK ITEM</b> 18219	<b>59,02</b>	36,56
<b>COLOUR RANGE FIRE</b> 	<b>BEECH STEAMED</b>		
 PS calm (Nature)	<b>STOCK ITEM</b> 15507	<b>41,41</b>	27,81
 PS lively colourful (structure)	<b>STOCK ITEM</b> 15521	<b>35,84</b>	26,57
<b>WP PLANK SWITCH</b>	WP Charisma 3-Strip in all colours, gradings and surfaces	60865	<b>96,82</b>

## SURCHARGE EDGE PROFILES

EUR/lm

EDGE PROFILE 40 SYLE

+ 3,60

EDGE PROFILE 58 SYLE

+ 5,67

EDGE PROFILE BLOCK SYLE (riser is supplied loose)

+ 40,17

All prices for WP Multi and Extras can be found on page 134

\*no sapwood

Stock item delivery time: promptly ex works (from 200 m<sup>2</sup> on request)

All deliveries are based on the General Terms and Conditions of Business of Weitzer Parkett. All rights reserved for changes, composition and printing errors.

## WP CHARISMA 3-STRIP

3-layer | Dimensions: 2245 x 193 x 14 mm | 1 Package = 2,60 m<sup>2</sup>



COLOUR RANGE	COLOUR RANGE			ITEM NO.	EUR/m <sup>2</sup>	EDGE PROFILE 40 FOR STEPS EUR/lm Item No. 29888
NATURE	OAK					
PS	exquisite (exquisite)	STOCK ITEM		15422	55,83	32,45
PS	calm (Nature)	STOCK ITEM		15426	43,47	29,77
PA+	calm (Nature)	STOCK ITEM		18174	43,47	29,77
PVf	calm (Nature)	STOCK ITEM		29138	45,53	30,18
PS	lively colourful (structure)	STOCK ITEM		15431	37,60	28,43
PA+	lively colourful (structure)	STOCK ITEM		18173	37,60	28,43
PVf	lively colourful (structure)	STOCK ITEM		29144	39,66	28,84
NATURE	OAK PURE					
PA+	calm (Nature)	STOCK ITEM		28080	47,59	33,78
STONE	OAK AUSTER					
PA+	calm (Nature)	STOCK ITEM		29743	47,59	33,78
STONE	OAK KASCHMIR					
PA+	calm (Nature)	STOCK ITEM		18185	47,59	33,78
STONE	OAK SAVANNE					
PA+	calm (Nature)	STOCK ITEM		22525	47,59	33,78

<b>WP PLANK SWITCH</b>	WP Charisma 3-Strip in all colours, gradings and surfaces	60865	<b>96,82</b>
------------------------	---	-------	--------------

SURCHARGE EDGE PROFILES		EUR/lm
<b>EDGE PROFILE 40 SYLE</b>		+ 3,60
<b>EDGE PROFILE 58 SYLE</b>		+ 5,67
<b>EDGE PROFILE BLOCK SYLE</b> (riser is supplied loose)		+ 40,17

All prices for WP Multi and Extras can be found on page 134

Stock item delivery time: promptly ex works (from 200 m<sup>2</sup> on request)  
All deliveries are based on the General Terms and Conditions of Business of Weitzer Parkett. All rights reserved for changes, composition and printing errors.

## WP CHARISMA 3-STRIP

3-layer | Dimensions: 2245 x 193 x 14 mm | 1 Package = 2,60 m<sup>2</sup>

CLOUR RANGE	ASH POLAR	ITEM NO.	EUR/m <sup>2</sup>	EDGE PROFILE 40 FOR STEPS EUR/m Item No. 29888
COLOUR RANGE STONE				
PA+ calm (select)	<b>STOCK ITEM</b>	18223	<b>50,47</b>	34,61
COLOUR RANGE SAND	CANADIAN MAPLE			
PS calm (Nature)	<b>STOCK ITEM</b>	15610	<b>59,95</b>	35,54
PA+ calm (Nature)	<b>STOCK ITEM</b>	18217	<b>59,95</b>	35,54
PS lively colourful (structure)	<b>STOCK ITEM</b>	15611	<b>51,91</b>	33,78
COLOUR RANGE SAND	ASH			
PS calm (select)	<b>STOCK ITEM</b>	15474	<b>46,35</b>	30,59
PS lively colourful (structure)	<b>STOCK ITEM</b>	15475	<b>35,12</b>	28,12

## WP PLANK SWITCH

WP Charisma 3-Strip in all colours, gradings and surfaces

60865

96,82

## SURCHARGE EDGE PROFILES

EUR/m

EDGE PROFILE 40 SYLE

+ 3,60

EDGE PROFILE 58 SYLE

+ 5,67

EDGE PROFILE BLOCK SYLE (riser is supplied loose)

+ 40,17

All prices for WP Multi and Extras can be found on page 134

Stock item delivery time: promptly ex works (from 200 m<sup>2</sup> on request)

All deliveries are based on the General Terms and Conditions of Business of Weitzer Parkett. All rights reserved for changes, composition and printing errors.



## WP CHARISMA 3-STRIP WOODEN STAIRS WP MULTI

Prices apply for all colours, surface finishes, grades, and additional treatments.

PROFILE 40	SPECIES	TREAD PANEL without Carrier panel   Item No.: 29873		RISER Item No.: 54272	WALL COVERING Item No.: 54333
		EURO/ STEPS/linear meters straight	EURO/ STEPS/linear meters L- and U-SHAPED	EURO/ STEPS/linear meters	EURO/ linear meters
	Fumed Oak	70,56	82,92	33,48	56,24
	Nut steamed	87,45	102,79	41,72	69,63
	Robinia steamed	74,37	87,34	35,33	57,78
	Cherry steamed	72,61	85,28	34,51	57,78
	Beech steamed	62,42	73,34	29,56	49,85
	Oak	62,83	73,85	29,87	50,06
	Ash	62,83	73,85	29,87	50,06
	Canadian Maple	70,14	82,40	33,37	56,13
	White (RAL 9010)	-	-	21,22	-
SURCHARGE					
PROFILE 40 STYLE		9,48	9,48	-	-
PROFILE 58 STYLE		11,54	11,54	-	-
PROFILE BLOCK STYLE		40,17	40,17	Riser is included in the price and is supplied loose.	-
Carrier panel 6 mm, 17 mm or 27 mm		15,04	15,04	9,17	9,17
Customization Only possible with digital measuring system or stencils/moulds		14,63	17,41	15,96	Is customized
Riser pre-drilled, including screws Minimum thickness 19 mm		-	-	13,70	-

Orders for prefab tread panels possible using the WP Multi measurement sheet.  
Templates for download from Weitzer Parkett Partner Portal.

WOODEN STAIRS WP MULTI   EXTRAS					
<b>Multi Front Edge (FE)</b> <b>PROFILE 40, 40 STYLE, BLOCK STYLE</b> Item No.: 40272   right/left   available on request without a tongue	350 mm   EURO/pc.	10,51	600 mm   EURO/pc.	13,49	
<b>Multi Front Edge (FE)</b> <b>PROFILE 58 STYLE</b> Item No.: 40272   right/left   available on request without a tongue	350 mm   EURO/pc.	11,54	600 mm   EURO/pc.	14,52	
<b>Multi Wall Cover Moulding (WCM)</b> <b>PROFILE 40, 40 STYLE, 58 STYLE BLOCK STYLE</b> Item No.: 40281   right/left, straight/L- and U-shaped	350 mm   EURO/pc.	10,51	650 mm   EURO/pc.	19,47	
<b>Multi Front Edge - Riser (FER)</b> <b>PROFILE 40/58 STYLE</b> for riser Item No.: 40463	white   EURO/lm	6,90	Species   EURO/lm Item No.: 40279	12,77	
<b>Multi Landing Wall Cover Moulding</b> Item No.: 40627	40 x 14 mm   EURO/lm		15,35		
<b>Multi Front Edge (FE) execute</b> for treads including material	Tread Panel + wall covering EURO/pc.		23,18		
<b>Edge Profile for Stairs 40 (LEP)</b> Item No.: 54295 Dimensions: 40 mm x 14 mm   curvature/radius: 3 mm Fixed length: 2500 mm   including false tongue	Colour range LAVA/TERRA EURO/lm	20,19	remaining colour scheme EURO/lm	16,07	

Further extras and detailed descriptions from page 141!





# STRIP APPEARANCE

## STANDS FOR DESIGN

MODERN AND MULTIFACETED,  
STRIP PARQUET WITH ITS  
NUANCED STRIPS CREATES  
IMPARTING SPECIAL ACCENTS  
IN YOUR ROOMS.



## WP STRIP 45

## 2-LAYER-PARQUET



- Unusually effective design - exclusively from Weitzer Parkett
- Extremely high-grade and long-lasting due to above-average solid wood wear layer of approx. 4.5 mm
- Tongue and groove joints on four sides **(01)**
- Supporting material made from moisture resistant HDF **(02)**
- Unbeatable price/performance ratio

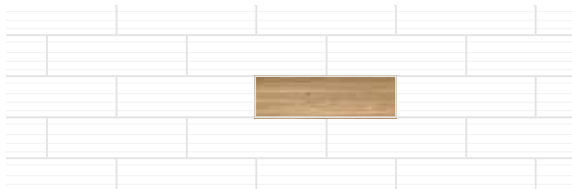

## DIMENSIONS:

360 x 108 x 11 mm

Overall thickness 11 mm with approx. 4,5 mm wear layer

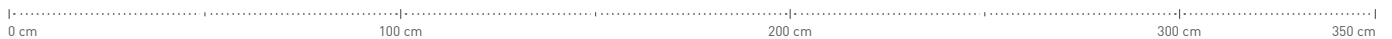









## PACKING UNITS

UNIT	PACKAGE	PALLET
CONTENTS	36 boards = 1,40 m <sup>2</sup> <small>(each package contains 50% right and 50% left blocks)</small>	50 packages = 70 m <sup>2</sup>
DIMENSIONS	0,37 x 0,23 x 0,21 m	1,20 x 0,80 x 1,20 m
WEIGHT	approx. 12,7 kg	approx. 635 kg
EDGE PROFILE FOR STEPS	Fixed length: 1,08 m, 1,44 m, 1,80 m or 2,16 m; Profile 40, 40 style, 58 style and Block style; Profile Block style: riser is delivered loose	



## COLOUR RANGE OVERVIEW

### STOCK ITEM

 <p>COLOUR RANGE <b>LAVA</b> <b>FUMED OAK</b> calm (nature)</p> <ul style="list-style-type: none"> <li>WP Strip 45</li> </ul>	 <p>COLOUR RANGE <b>TERRA</b> <b>NUT STEAMED</b> lively colourful (original)</p> <ul style="list-style-type: none"> <li>WP Strip 45</li> </ul>	 <p>COLOUR RANGE <b>FIRE</b> <b>ROBINIA STEAMED</b> lively colourful (original)</p> <ul style="list-style-type: none"> <li>WP Strip 45</li> </ul>	 <p>COLOUR RANGE <b>NATURE</b> <b>OAK</b> calm (nature)</p> <ul style="list-style-type: none"> <li>WP Strip 45</li> </ul>	 <p>COLOUR RANGE <b>NATURE</b> <b>OAK</b> lively colourful (structure)</p> <ul style="list-style-type: none"> <li>WP Strip 45</li> </ul>
 <p>COLOUR RANGE <b>STONE</b> <b>OAK KASCHMIR</b> calm (nature)</p> <ul style="list-style-type: none"> <li>WP Strip 45</li> </ul>	 <p>COLOUR RANGE <b>SAND</b> <b>ASH</b> calm (select)</p> <ul style="list-style-type: none"> <li>WP Strip 45</li> </ul>	 <p>COLOUR RANGE <b>SAND</b> <b>ASH</b> lively colourful (natural)</p> <ul style="list-style-type: none"> <li>WP Strip 45</li> </ul>		

















The grading overview serves as a rough orientation. To obtain a representative grading picture please see our official grading book or get info from our partner portal:  
<https://partner.weitzer-parkett.com>



## WP STRIP 45

2-layer | Dimensions: 360 x 108 x 11 mm | 1 Package = 1,40 m<sup>2</sup>

COLOUR RANGE	ITEM NO.	EUR/m <sup>2</sup>	EDGE PROFILE 40 FOR STEPS EUR/lm Item No. 29894
<b>COLOUR RANGE LAVA</b>  <b>FUMED OAK</b>			
 PA+ calm (Nature)	<b>STOCK ITEM</b> 28211	<b>52,53</b>	42,44
<b>COLOUR RANGE TERRA</b>  <b>NUT STEAMED</b>			
 PA+ lively colourful (original)	<b>STOCK ITEM</b> 28223	<b>72,10</b>	46,25
<b>COLOUR RANGE FIRE</b>  <b>ROBINIA STEAMED</b>			
 PA+ lively colourful (original)	<b>STOCK ITEM</b> 28246	<b>53,77</b>	42,64
<b>COLOUR RANGE NATURE</b>  <b>OAK</b>			
 PA+ calm (Nature)	<b>STOCK ITEM</b> 28888	<b>40,89</b>	37,59
 PVF calm (Nature)	<b>STOCK ITEM</b> 28204	<b>42,95</b>	37,90
 PA+ lively colourful (structure)	<b>STOCK ITEM</b> 18680	<b>35,43</b>	36,98
<b>COLOUR RANGE STONE</b>  <b>OAK KASCHMIR</b>			
 PA+ calm (Nature)	<b>STOCK ITEM</b> 28251	<b>45,01</b>	41,20
<b>COLOUR RANGE SAND</b>  <b>ASH</b>			
 PA+ calm (select)	<b>STOCK ITEM</b> 26839	<b>43,57</b>	38,21
 PA+ lively colourful (natural)	<b>STOCK ITEM</b> 29556	<b>33,06</b>	36,87

## SURCHARGE EDGE PROFILES

EUR/lm

EDGE PROFILE 40 SYLE

+ 11,02

EDGE PROFILE 58 SYLE

+ 13,08

EDGE PROFILE BLOCK SYLE (riser is supplied loose)

+ 53,25

All prices for WP Multi and Extras can be found on page 139

Stock item delivery time: promptly ex works (from 200 m<sup>2</sup> on request)

All deliveries are based on the General Terms and Conditions of Business of Weitzer Parkett. All rights reserved for changes, composition and printing errors.



## WP STRIP 45 WOODEN STAIRS WP MULTI

Prices apply for all colours, surface finishes, grades, and additional treatments.

PROFILE 40	SPECIES	TREAD PANEL including carrier panel (6 mm, 17 mm or 27 mm)   Item No.: 29881		RISER Item No.: 54285	WALL COVERING Item No.: 54347
		EURO/ STEPS/linear meters straight	EURO/ STEPS/linear meters L- and U-SHAPED	EURO/ STEPS/linear meters	EURO/ linear meters
	Fumed Oak	101,25	118,97	48,31	80,96
	Nut steamed	115,46	135,65	54,80	92,49
	Robinia steamed	101,45	119,17	48,51	81,16
	Oak	90,23	105,99	42,95	72,31
	Ash	90,23	105,99	42,95	72,31
	White (RAL 9010)	-	-	21,22	-
SURCHARGE					
PROFILE 40 STYLE		11,02	11,02	-	-
PROFILE 58 STYLE		13,08	13,08	-	-
PROFILE BLOCK STYLE		53,25	53,25	Riser is included in the price and is supplied loose.	-
Customization Only possible with digital measuring system or stencils/moulds		14,63	17,41	15,96	Is customized
Riser pre-drilled, including screws Minimum thickness 19 mm		-	-	13,70	-
Strip 45   „DESIGN“ installation see page 135		19,36	19,36	24,93	-

Orders for prefab tread panels possible using the WP Multi measurement sheet.  
Templates for download from Weitzer Parkett Partner Portal.

WOODEN STAIRS WP MULTI   EXTRAS					
Multi Front Edge (FE) PROFILE 40, 40 STYLE, BLOCK STYLE Item No.: 40272   right/left   available on request without a tongue	350 mm   EURO/pc.	10,51	600 mm   EURO/pc.	13,49	
Multi Front Edge (FE) PROFILE 58 STYLE Item No.: 40272   right/left   available on request without a tongue	350 mm   EURO/pc.	11,54	600 mm   EURO/pc.	14,52	
Multi Wall Cover Moulding (WCM) PROFILE 40, 40 STYLE, 58 STYLE BLOCK STYLE Item No.: 40281   right/left, straight/L- and U-shaped	350 mm   EURO/pc.	10,51	650 mm   EURO/pc.	19,47	
Multi Front Edge - Riser (FER) PROFILE 40/58 STYLE for riser Item No.: 40463	white   EURO/lm	6,90	Species   EURO/lm Item No.: 40279	12,77	
Multi Landing Wall Cover Moulding Item No.: 40627	40 x 14 mm   EURO/lm		15,35		
Multi Front Edge (FE) execute for treads including material	Tread Panel + wall covering EURO/pc.		23,18		
Edge Profile for Stairs 40 (LEP) Item No.: 54295 Dimensions: 40 mm x 14 mm   curvature/radius: 3 mm Fixed length: 2500 mm	Colour range LAVA/TERRA EURO/lm	20,19	remaining colour scheme EURO/lm	16,07	

Further extras and detailed descriptions from page 141!





# WOODEN STAIRS WP MULT

## PARQUET AND STAIRS IN IDENTICAL COLOURS

THE PERFECT FINISH  
TO YOUR INTERIOR.



06

## LOOSE EDGE PROFILE FOR STEPS (LEP)

Quick and flexible solution  
on site! Fixed length: 2500 mm

(including tongue with Imperial Plank, WP Charisma,  
WP Comfort Plank and WP Strip 45)



06

TREAD PANEL  
**PROFILE 40**

05

03

RISER

TREAD

01

04

02

TREAD PANEL  
**PROFILE 40 STYLE**

02

TREAD PANEL  
**PROFILE 58 STYLE**

02

TREAD PANEL  
**PROFILE BLOCK STYLE**

02

## 03 MULTI FRONT EDGE - RISER (FER)

Covers the side of the risers (vertically) and rounds off the overall picture of the staircase. It is available in white (see image) or in all parquet appearances.

## 04 MULTI WALL COVER MOULDING (WCM)

The final touch for wall clearance. Offers protection against abrasion and dirt.

## 05 MULTI FRONT EDGE (FE)

The Multi Front Edge covers the open sides of the tread. The Multi Front Edge is provided with a permanent tongue. A router and a 4 mm groove cutter with thrust ring are needed for installation.

### PROFILE 40:

Dimensions: 350 x 40/58 x 6 mm | Dimensions: 600 x 40/58 x 6 mm

Also available **without** tongue!

Precise,  
stable  
fixation of  
Front Edge  
(FE) \*



\* Grooves must be cut during installation

## 03 + 04 + 05 WP MULTI MOULDING SYSTEM

The intelligent moulding system made of genuine wood for all applications—whether straight, L- or U-shaped, or slanting. Consisting of **Multi Front Edge (FE)**, **Multi Front Edge - Riser (FER)**, and the **Wall Cover Moulding (WCM)**, they fit every Weitzer Parkett and every multi-stair variation. **Available in every wood species and colour of the Weitzer Parkett assortment.**

WEITZER PARKETT OFFERS MATCHING STAIRS FOR EVERY PARQUET FLOOR - IRRESPECTIVE OF WHICH TIMBER OR COLOUR TONE YOU USE - CREATING COLOUR CONSISTENCY THROUGHOUT



**01** EDGE PROFILE FOR STEPS (EP)

The stair-edge profile consists of a multi-moulding and a parquet strip (profile 40). The profile for the 40 style, 58 style and block style variants is crafted from a single piece of parquet. The stair-edge profile is the termination of each stair (exit) and allows the adjacent parquet to continue to be laid seamlessly. (continued frontal laying on request)

Immediately click on For example continue installation



**PROFILE 40**  
40 mm edge band



**PROFILE 40 STYLE**  
40 mm



**PROFILE 58 STYLE**  
58 mm



**PROFILE BLOCK STYLE**  
Variable riser\*

\* Height depends on each product. SYMBOLIC PHOTOS

**02** TREAD PANEL

Consists of several parquet strips (number of parquet strips varies depending on parquet appearance) and terminates at the longitudinal sides each with multi-moulding.

**AVAILABLE MODELS:**

Profile 40, 40 style, 58 style and Block style profile

**You'll find a detailed description of the individual profiles on the next page.**



Standard 17 mm thick carrier panel, 6 mm or 27 mm thickness deliverable on request

Two treads can be produced per large die plate.

TREAD COMBINATION

Exemplary presentation of the tread combination for each cut is displayed on the back side. However this serves only as guidance. Exact measures must always be taken on site!



PLANK APPEARANCE\*



WIDEBOARD APPEARANCE

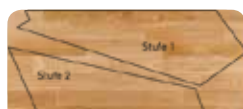

BLOCK APPEARANCE

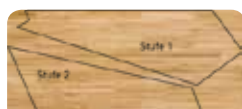

STRIP APPEARANCE  
„CLASSIC“ installation

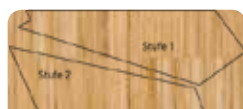

STRIP APPEARANCE  
„DESIGN“ installation

\* Continuous top layer (no header joint) is possible at an extra cost.



## THE TREAD PANEL IN DETAIL

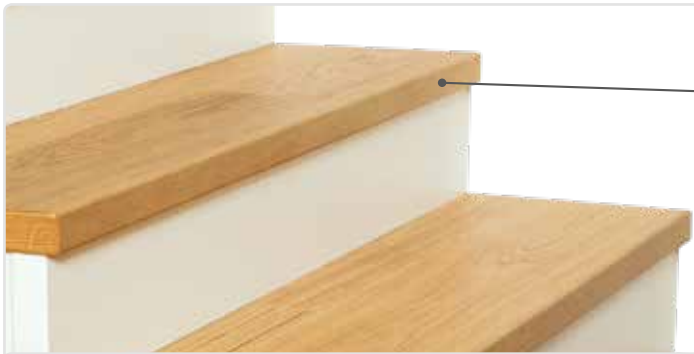

Consists of several parquet strips\* and connects each longitudinal side with a multi-moulding. **Two treads** can be produced per tread panel. Edge radius: 5 mm

TREAD PANEL **PROFILE 40**

Consists of several parquet strips and terminates with a mitred parquet surface on each of the longitudinal sides. Two step treads can be produced per large-format tread. Edge radius: 3 mm

TREAD PANEL **PROFILE 40 STYLE**

Consists of several parquet strips and terminates with a mitred parquet surface on each of the longitudinal sides. Two step treads can be produced per large-format tread. Edge radius: 3 mm

TREAD PANEL **PROFILE 58 STYLE**

Perfect joining technology!  
Joining the riser and tread without shadow gap.  
Edge radius: 3 mm

TREAD PANEL **PROFILE BLOCK STYLE**

\* **Number of parquet strips** varies depending on parquet appearance.

\*\* **Height** depends on each product.

# PROFESSIONAL INSTALLATION WITH SCREW CONNECTED RISER

FOR A PERFECT RESULT

OPTIMIZED INSTALLATION CONDITIONS  
OF THE RISER USING AN EXACT  
EDGE AND PRE-DRILLED  
THREADED-CONNECTION HOLES.



## YOUR BENEFITS AT A GLANCE:

- Prefabricated riser as an ideal solution to cover existing structure **(01)** (Brickworks/Painting not necessary)
- Pre-drilled, countersunk threaded connection in the riser **(02)** (simple one-man installation)
- Remarkable saving of installation time

### FORCE-FIT CONNECTION

of the riser  
with the tread

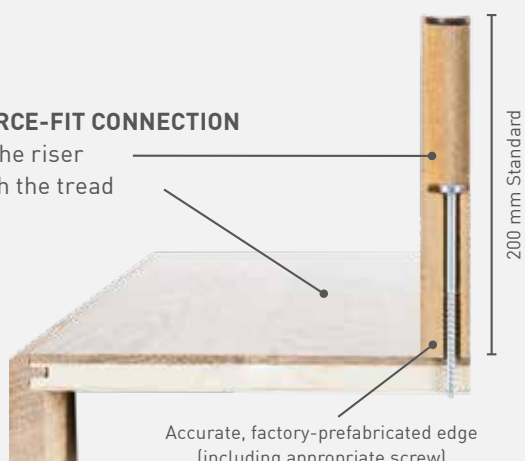

Accurate, factory-prefabricated edge  
(including appropriate screw)





## WP MULTI POSSIBILITIES

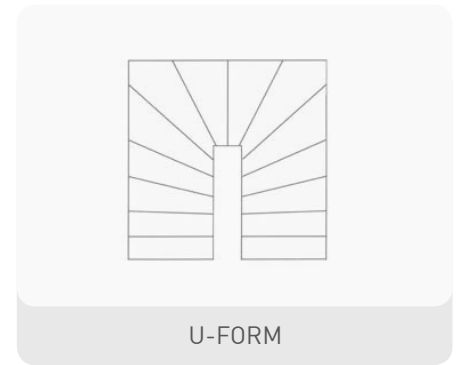
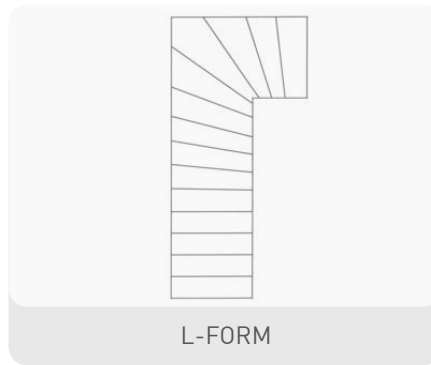
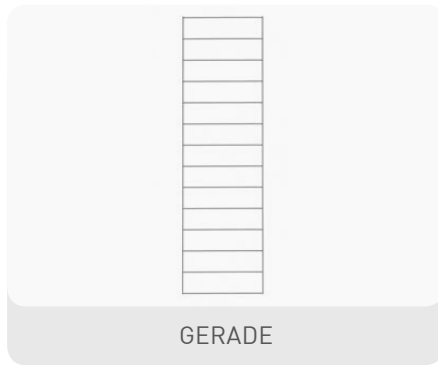

## WP MULTI PRICING/EXAMPLE

**Material:** TREAD PANEL (Block appearance | WP Charisma 3-Strip | Oak | natur | ProActive+)  
profile 40 (with carrier panel )  
U-SHAPED  
14 steps  
Tread width: ? [CALCULATION EXAMPLE FOR TREAD WIDTH BELOW]

**Step 1: Average tread width determination**

- Measure the staircase's entrance (1) and exit (2)
- Calculate the average of the two tread widths:  
 $106 \text{ cm} + 115 \text{ cm} = 221 \text{ cm} : 2 = \mathbf{111 \text{ cm} = 1,11 \text{ m tread width}}$   
(Round to two decimal places)

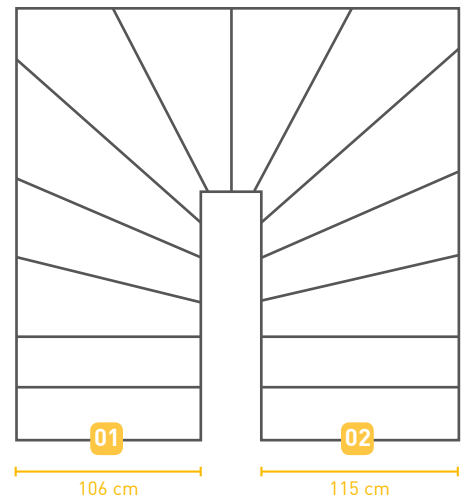
**Step 2: Price determination**

Tread Panel profile 40 (L-and U-SHAPED)

Wood species Oak 73,85  
+ carrier panel surcharge 15,04

= Price per linear meter 88,89  
x average tread width 1,11

= Price per step 98,66  
x 14 steps 14

= **Total price** **1.381,33**

		TREAD PANEL		RISER		WALL CHINEERS	
PROFILE 40	WOOD SPECIES	PRICE PER LINEAR METER	PRICE PER LINEAR METER	PRICE PER LINEAR METER	PRICE PER LINEAR METER	PRICE PER LINEAR METER	PRICE PER LINEAR METER
Profile 40	Oak	70,54	82,71	20,08	24,24	-	-
	Maple	87,07	100,79	24,32	29,62	-	-
	Cherry	70,61	82,79	20,21	24,79	-	-
	Birch	62,62	72,34	18,54	22,85	-	-
	Oak	42,93	51,85	12,07	14,54	-	-
	Maple	42,93	51,85	12,07	14,54	-	-
	Cherry	70,54	82,71	20,08	24,24	-	-
	Walnut	70,54	82,71	20,08	24,24	-	-
	White Oak	70,54	82,71	20,08	24,24	-	-
SURCHARGE		PRICE PER LINEAR METER	PRICE PER LINEAR METER	PRICE PER LINEAR METER	PRICE PER LINEAR METER	PRICE PER LINEAR METER	PRICE PER LINEAR METER
	Profile 40	15,04	15,04	-	-	-	-
	Profile 40	15,04	15,04	-	-	-	-
	Profile 40	15,04	15,04	-	-	-	-
	Carrier panel	15,04	15,04	9,17	9,17	-	-
	Customization	14,82	17,41	15,94	-	-	-
	Riser pre-drilled, including screws	-	-	13,70	-	-	-

WOODEN STAIRS WP MULTI   PROFILE		PRICE PER LINEAR METER	PRICE PER LINEAR METER
Profile 40	Profile 40, 40 STYLE, BLOCK STYLE	10,51	400 mm   10,51
Profile 40	Profile 40, 40 STYLE, BLOCK STYLE	11,54	400 mm   11,54
Profile 40	Profile 40, 40 STYLE, BLOCK STYLE	11,54	400 mm   11,54
Profile 40	Profile 40, 40 STYLE, BLOCK STYLE	10,51	400 mm   10,51
Profile 40	Profile 40, 40 STYLE, BLOCK STYLE	6,70	400 mm   6,70
Profile 40	Profile 40, 40 STYLE, BLOCK STYLE	15,10	400 mm   15,10
Profile 40	Profile 40, 40 STYLE, BLOCK STYLE	15,10	400 mm   15,10

**DON'T FORGET:**  
STAIR-EDGE PROFILE  
FOR THE PERFECT  
FINISH!

Further extra and detailed descriptions from page 14/11

## SOLID HAND RAILS



**HAND RAIL HL 50**  
40 x 55 mm



**HAND RAIL HL 80**  
80 x 40 mm\*\*

\*\* 5 mm edge radius



**ROUNDING**  
of handrail ends



**LONGITUDINAL FINGER JOINT**

SPECIES	GRADING	SURFACE	PROFILE & LENGTH	EURO/tm
<b>Item No. 40 430</b>				
Nut steamed	nature	PS, PA+ and PV f	HL 50 and HL 80   up to 2500 mm*	63,96
Robinia steamed	nature	PS, PA+ and PV f	HL 50 and HL 80   up to 2500 mm*	56,55
Beech steamed	nature	PS and PA+	HL 50 and HL 80   up to 2500 mm*	32,45
Oak	nature	PS, PS m, PA+, PV f	HL 50 and HL 80   up to 2500 mm*	42,13
Ash	nature	PS and PA+	HL 50 and HL 80   up to 2500 mm*	34,20
Rounding of handrail ends   Price per pc.				11,12
Longitudinal finger joint   Price per pc.				32,14

\* over 2500 mm with longitudinal finger joint

### SURCHARGE HAND RAIL FOR COLOURS

EURO/tm

SPECIES	SURFACE	EURO/tm
<b>COLOUR RANGE LAVA</b>		
Fumed Oak Ice	PA+ and PV f	9,79
Fumed Oak	PS, PA+ and PV f	6,70
Fumed Oak Melange	PV f	9,79
<b>COLOUR RANGE TERRA</b>		
Oak Cognac	PA+ and PV f	7,73
Oak Coffee	PA+ and PV f	7,73
Oak Havanna	PA+ and PV f	7,73
Oak Krokant	PA+	7,73
<b>COLOUR RANGE NATURE</b>		
Oak Mandel	PA+ and PV f	7,73
Oak Pure	PA+ and PV f	7,73
<b>COLOUR RANGE STONE</b>		
Oak Auster	PA+ and PV f	7,73
Oak Kaschmir	PA+ and PV f	7,73
Oak Ice	PA+ and PV f	9,79
Oak Savanne	PA+ and PV f	7,73
Ash Polar	PA+	9,79
Oak Polar	PA+ and PV f	9,79
Oak Trüffelgrau	PA+ and PV f	9,79
Oak Colorado Diamond Ice	PA+ und PV f	9,79
Oak Taupe	PV f	7,73
<b>COLOUR RANGE SAND</b>		
Ash Latte	PA+	7,73



Delivery time massive hand rail ProStrong and ProActive+: 12 working days from order confirmation ex works. Delivery time massive hand rail ProVital finish: 20 working days from order confirmation ex works.

The natural product wood has a long delivery time. A considerably longer deliver time can also result from heavy demand. All deliveries are subject to the Weitzer Parkett Company's general terms and conditions. Changes, composition and printing errors are reserved.

## ACCESSORIES WP MULTI

			ITEM NO.	EURO / UNIT
<b>Handrail Brackets</b>				
	HL 50 and HL 80	white	13 776	6,90/pc.
	HL 50 and HL 80	stainless steel	13 773	13,49/pc.



# PARQUET MOULDING SYSTEM

## FROM SIMPLE TO ELEGANT

INTELLIGENT AND PROVEN  
SOLUTIONS FOR THE  
PERFECT FINISH  
OF YOUR INTERIOR.

# PARQUET SKIRTINGS

A MATCHING  
SKIRTING FOR  
EVERY FLOOR.

## VENEERED SKIRTINGS

CLIPSYSTEM



**SF 40 \*** – Length 2500 mm

CLIPSYSTEM



**SF 58** – Length 2500 mm

CLIPSYSTEM

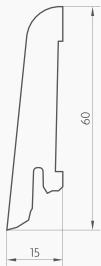

**SF 60** – Length 2500 mm



**SF 82** – Length 2500 mm

CLIPSYSTEM

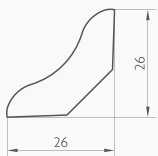

**PF 24** – Length 2500 mm



**PF 40** – Length 2500 mm



## VENEERED SKIRTINGS









## SOLID SKIRTINGS

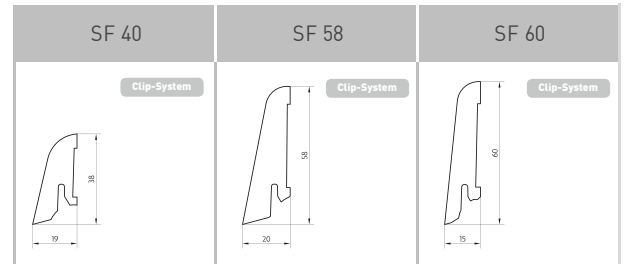



## VENEERED SKIRTINGS



SURFACE	SPECIES	ITEM NO.	EURO/lm	ITEM NO.	EURO/lm	ITEM NO.	EURO/lm
 <b>PROSTRONG</b>	<b>COLOUR RANGE TERRA</b>						
	Nut steamed	13697	3,50				
 <b>PROSTRONG</b>	<b>COLOUR RANGE FIRE</b>						
	Robinia steamed	13687	3,50				
	Cherry steamed	13677	2,99				
	Beech steamed	13671	2,99			16245	3,30
 <b>PROSTRONG</b>	<b>COLOUR RANGE NATURE</b>						
	Oak	13653	2,99	16240	3,81	16246	3,30
 <b>PROACTIVE+</b>	<b>COLOUR RANGE STONE</b>						
	Oak Kaschmir	22759	4,02				
 <b>PROSTRONG</b>	<b>COLOUR RANGE SAND</b>						
	Canadian Maple	13683	2,99			16244	3,30
	Ash	13664	2,99				

## PACKING UNITS

25 lm/pack

## INFORMATION

Partial packing quantity: Surcharge 20 %  
 Base: Solid wood (mostly spruce)  
 Surface Finish: ProStrong or ProActive+  
 Packing: Cardboard

## VENEERED SKIRTINGS

		SF 82		PF 24		PF 40	
SURFACE	SPECIES	ITEM NO.	EURO/lm	ITEM NO.	EURO/lm	ITEM NO.	EURO/lm
	<b>COLOUR RANGE FIRE</b>						
<b>PROSTRONG</b>	Beech steamed			16215	2,58	16227	2,78
	<b>COLOUR RANGE NATURE</b>						
<b>PROSTRONG</b>	Oak			16216	2,58	16229	2,78
<b>PROACTIVE+</b>	Oak	24366	6,39				
	<b>COLOUR RANGE SAND</b>						
<b>PROACTIVE+</b>	Spruce off-white	29135	7,52				

### PACKING UNITS





25 lm/-pack

### INFORMATION

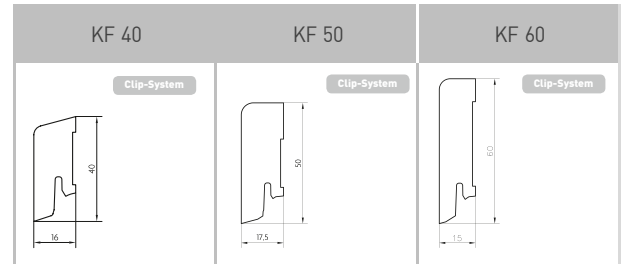
Partial packing quantity: Surcharge 20 %  
 Base: Solid wood (mostly spruce)  
 Surface Finish: ProStrong or ProActive+  
 Packing: Cardboard

## VENEERED SKIRTINGS



SURFACE	SPECIES	ITEM NO.	EURO/lm	ITEM NO.	EURO/lm	ITEM NO.	EURO/lm
	<b>COLOUR RANGE LAVA</b>						
PROACTIVE+	Fumed Oak Ice						
	digital print	22706	5,67				
	Fumed Oak	48330	5,67				
	<b>COLOUR RANGE TERRA</b>						
PROACTIVE+	Oak Krokant	29070	4,43				
	Eiche Havanna	29071	4,43				
	Oak Coffee	22688	4,43				
	Nut steamed	22686	4,43				
	Oak Cognac	29072	4,43				
	<b>COLOUR RANGE FIRE</b>						
PROACTIVE+	Robinia steamed	22692	5,05				
	<b>COLOUR RANGE NATURE</b>						
PROACTIVE+	Oak Pure	29074	4,43			50064	5,05
	Oak	22694	3,50	22711	4,33	22718	4,33
	Oak Mandel	22693	4,43				
PROFINE	Oak	29082	3,50				

## PACKING UNITS

25 lm/pack

## INFORMATION

Partial packing quantity: Surcharge 20 %  
 Base: Solid wood (mostly spruce)  
 Surface Finish: ProStrong or ProActive+  
 Packing: Cardboard

## VENEERED SKIRTINGS

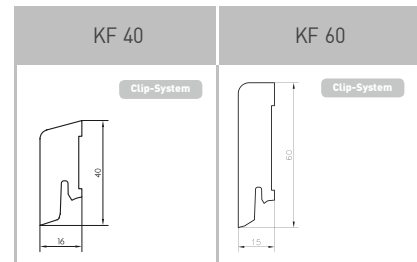

SURFACE	SPECIES	ITEM NO.	EURO/lm	ITEM NO.	EURO/lm	ITEM NO.	EURO/lm
PROACTIVE+	<b>COLOUR RANGE STONE</b>						
	Oak Auster			22698	4,43	50065	5,05
	Oak Kaschmir			22697	4,43	50062	5,05
	Oak Ice			22695	4,43		
	Oak Savanne			22700	4,43	50063	5,05
	Ash Polar			29061	4,43		
	Oak Polar			29077	4,43		
	Oak Taupe			29064	4,43		
	Oak Colorado Diamond Ice			62295	5,67		
Oak Trüffelgrau			29065	5,05			
PROACTIVE+	<b>COLOUR RANGE SAND</b>						
	Spruce off-white			50045	3,50		
	Stone pine Edelweiss			29081	5,05		
	Ash Latte			22705	4,43		
	Canadian Maple			22702	3,50		
	Ash			22701	3,50		



### Clip-Star – suitable for brickwork

This intelligent and globally unique invisible fastening system enables fast and simple assembly.  
Fastener distance: 25-50 cm

1 Box of 50      40 362      12,15/pc.

### Clip-Star – suitable for drywall construction

This intelligent and globally unique invisible fastening system enables fast and simple assembly.  
Fastener distance: 25-50 cm

1 Box of 50      29 383      12,15/pc.

### PACKING UNITS

25 lm/pack

### INFORMATION

Partial packing quantity: Surcharge 20 %  
Base: Solid wood (mostly spruce)  
Surface Finish: ProStrong or ProActive+  
Packing: Cardboard

## SOLID SKIRTINGS

## PACKING UNITS

SP 50	24 lm/pack
SP 95	12 lm/pack

## INFORMATION

Partial packing quantity:	Surcharge 20 %
Surface Finish:	ProStrong, ProVital finish or ProFine
Packing:	Foil, specifications (measurement, type) on the backside

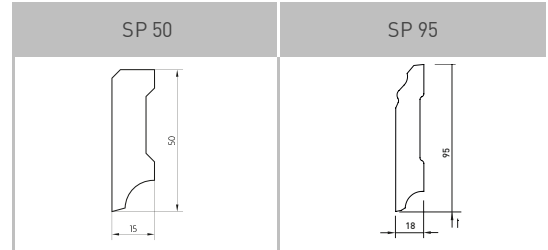

SURFACE	SPECIES	ITEM NO.	EURO/lm	ITEM NO.	EURO/lm
	<b>COLOUR RANGE NATURE</b>				
<b>PROSTRONG</b>	Oak	16291	8,86		
<b>PROVITAL f</b>	Oak deep brushed	58764	10,92		
<b>PROFINE</b>	Oak	16292	8,86		
	Oak deep brushed	58763	10,09		

	<b>COLOUR RANGE SAND</b>				
<b>PROACTIVE+</b>	Pin off-white	22747	6,08	22764	8,86

	<b>iDESIGN PARKETT®</b>				
<b>PROVITAL f</b>	iDesign Parkett Oak	<b>iDESIGN PARKETT®</b>	23345	15,55	
	Available in every colour in the iDesign Parkett product range				
	Surcharge "deep brushed"			+ 2,06	

\* Delivery time iDesign Parkett (from 24 lm): 3 to max. 4 weeks ex works.

Stock items. Delivery time: promptly ex works. Varying levels of demand may result in significantly longer delivery times for items.

Sales prices are ex works, and delivery is in full boxes only. All deliveries are based on the General Terms and Conditions of Business of Weitzer Parkett. All rights reserved for changes, composition and printing errors.

# PARQUET ACCESSORIES

## FOR A LONG PARQUET LIFE!

WITH THE RIGHT ACCESSORIES,  
THE PARQUET STAYS BEAUTIFUL  
YEARS AFTER ITS INSTALLATION



# GUARANTEED FREE FROM PLASTICIZERS

WEITZER PARKETT  
SETS STANDARDS:  
WITH A UNIQUE OVERALL  
SOLUTION FREE FROM  
PLASTICIZERS!

ENVIRONMENTALLY  
FRIENDLY

We are the first and only provider on the market to offer you an overall solution free from plasticizers: from the parquet floor to the adhesive. Another contribution to improved health and the preservation of Mother Nature.

Weitzer Parkett is well aware of its environmental responsibility and implements this throughout the entire value-added chain - from the procurement of raw materials right up to our wood waste recycling. In the same manner, we place great emphasis on using environmentally safe products required in the production of our parquet flooring.

## PROFI SMP ADHESIVE NO. 950



### PRODUCT DETAILS

- 1-component, label-free adhesive
- Use with 2- and 3-layer parquet:  
1000 g/m<sup>2</sup> to 1200 g/m<sup>2</sup>
- Application: suitable for complete adhesion of solid wood floors, 2-layer and 3-layer parquet\*

## YOUR BENEFITS AT A GLANCE:

- free from Plasticizers
- does not contain potentially migrating components after curing
- free from solvents and water
- Sustainability: Parquet that has been removed after a long period of use can in future be fed into the recycling execute at significantly lower cost. Thanks to the environmentally friendly adhesive, no harmful substances can be absorbed by the wood, which means that it can be fully recycled for future use.

Easy-to-execute, exemplary solution –in terms of the environment and economics

## SAFETY INCLUDED.

The fidbox® is a climate monitor that is hidden in the parquet for measuring the temperature (°C) and relative humidity (%), and a data logger for ongoing data recording all in one. The data stored in the device can be read at any time and allows for determination of the temperature as well as the level of humidity of the screed/subfloor and wood. Not only is this information of interest when it comes to room climate, it also provides clear evidence in the event of damage.







## YOUR BENEFITS AT A GLANCE:

- The fidbox® has already been used on numerous occasions to indemnify parquet installers in cases of claims against them. The device measures the temperature and relative humidity and consequently provides recognised data that can be verified by experts.
- The **fidbox®** is integrated in the parquet floor. The stored data can be easily read out at a later stage by using a specific **APP**.
- The **fidbox® APP** enables end customers, builders, or the building supervision company to constantly monitor indoor climatic conditions remotely (via Bluetooth). This also applies in particular to residences that have stood empty for a long time.





Installing a fidbox® is mandatory for the WP Grand plank. This enables you to seek specialist advice and optimize your indoor climate even after the parquet has been laid, thereby ensuring the value of the parquet floor is preserved. This will ensure your clients can look forward to a long and happy life together with their parquet floor.

## ADHESIVES

		PACKAGING UNIT	ITEM NUMBER	EURO /UNIT
	<p><b>Profli SMP Glue No. 950 - EC 1 - R+</b></p> <p>is an one component glue, free of softeners, solventfree and water-free – no labeling required. Residues of glue are easy to remove. Consumption: appr. 1100-1300g/m<sup>2</sup> Suitable for complete adhesion of solid, 2-layer and 3-layer parquet.</p> <p><b>FREE OF SOFTENERS!</b></p>	33 buckets per pallet 18 kg each	29 614	10,20/kg
	<p><b>Profli SMP Glue Nr. 900 - EC 1</b></p> <p>is an elastic one-component SMP parquet adhesive. Consumption: 1100-1300 g/m<sup>2</sup> Suitable for complete adhesion of 2-layer parquet 9-13 mm as well as 3-layer parquet 14 mm</p>	33 buckets per pallet 18 kg each	22 748	6,70/kg
	<p><b>Profli SMP Glue Nr. 400 - EC 1</b></p> <p>Solvent free, one-component, gun applied floors 15-21 mm and 3-layer parquet 14 mm. polyurethane elastic adhesive. Consumption: 2 m<sup>2</sup>/bag. Suitable for liquid batten adhesion of solid floors 15-21 mm and 3-layer parquet 14 mm.</p>	20 bags per box 600 ml each	22 749	7,83/bag
	<p><b>Application Tool for Profli-SMP Glue No. 400-EC 1</b></p> <p>AVON application gun for bags of 600 ml</p>	a piece	13 783	74,78/pc.
	<p><b>PVA-Glue</b></p> <p>Ready for use, high quality PVA - Glue for glueing tongue and groove connections of 3-layer parquet Non frost resistant, solvent-free</p>	a piece à 0,75 kg	13 793	6,80/pc.
	<p><b>Cleaning tissues</b></p> <p>for removing fresh residues of glue</p>	1 bucket	29 616	29,46/buc.
	<p><b>WP Repamed</b></p> <p>Solvent-free, 1-C liquid polyurethane adhesive repair kit for easy removal of voids or to glue loose strips</p>	1 Set 50 ml	21 186	33,78/set





## PROSTRONG MAINTENANCE & CARE



		PACKAGING- UNIT	ITEM NUMBER	EURO / UNIT
	<p><b>ProStrong Polish</b> a water-based care product with excellent adhesion on ProStrong surfaces, particularly developed to ensure easy and straightforward care of sealed floors. ProStrong Polish is soil-resistant and leaves a slightly shimmering look. Consumption: 30-40 ml/m<sup>2</sup></p> <p><b>ATTENTION:</b> No longer required for usage in residential living</p>	12 bottles per box 1 lt each	13 722	16,69/lt
	<p><b>Clever Cleaner</b> Specially developed, high-concentrated cleaner for Maintenance-free ProStrong and ProActive+ surface finishes by Weitzer Parkett Solvent- and Formaldehyde free.</p>	15 bottles per box 1 lt each	19 280	14,73/lt
	<p><b>Cleaning Soap No.20</b> a high-quality, concentrated combined soap, based on natural oils/resins and therefore biodegradable. Consumption: 30 ml/10 lt water/100 m<sup>2</sup></p>	6 bottles per box 1 lt each	13 770	14,73/lt



## PROACTIVE+ MAINTENANCE &amp; CARE

		PACKING UNIT	ITEM NUMBER	EURO / UNIT
	<p><b>ProActive+ Polish</b> a water-based care product with excellent adhesion on ProActive+ surfaces, particularly developed to ensure easy and straightforward care of sealed floors. ProActive+ polish is soil-resistant and leaves a matt look. Consumption: 30-40 ml/m<sup>2</sup> <b>ATTENTION: No longer required for usage in residential living!</b></p>	12 bottles per box 1 lt each	19 279	16,69/lt
	<p><b>Clever Cleaner</b> Specially developed, high-concentrated cleaner for Maintenance-free ProStrong and ProActive+ surface finishes by Weitzer Parkett Solvent- and Formaldehyde free.</p>	15 bottles per box 1 lt each	19 280	14,73/lt
	<p><b>Cleaning Soap No.20</b> a high-quality, concentrated combined soap, based on natural oils/resins and therefore biodegradable. Consumption: 30 ml/10 lt water/100 m<sup>2</sup></p>	6 bottles per box 1 lt each	13 770	14,73/lt

**PROVITAL finish** MAINTENANCE & CARE

		PACKING UNIT	ITEM NUMBER	EURO / UNIT
	<b>ProVital Oil</b> consists entirely of natural materials such as linseed oil, bees wax and offers solvent free maintenance with a silky sheen finish. The wax guarantees optimal surface protection.  Consumption: 26 ml/m <sup>2</sup> (about 35 m <sup>2</sup> /container)	2 tins per box 2,5 lt each	29 426	37,90/lt
		6 tins per box 0,75 lt each	29 425	32,24/tin
	<b>ProVital Color Oil</b> the same composition and characteristics as ProVital Oil, but contains additional pollutant-free mineral pigments to enable different colors to be achieved. Application rate: 26 ml/m <sup>2</sup> (about 35 m <sup>2</sup> /container)			
	<b>COGNAC</b>	1 tin 0,125lt	29 394	12,36/tin
	<b>HAVANNA</b>	1 tin 0,125lt	29 393	12,36/tin
	<b>KROKANT</b>	1 tin 0,125lt	50 110	12,36/tin
	<b>MANDEL</b>	à 0,125 l	29 392	12,36/tin
	<b>PURE</b>	1 tin 0,125lt	50 109	12,36/tin
	<b>AUSTER</b>	1 tin 0,125lt	29 398	12,36/tin
	<b>KASCHMIR</b>	1 tin 0,125lt	29 399	12,36/tin
	<b>SAVANNE</b>	1 tin 0,125lt	50 108	12,36/tin
	<b>POLAR</b>	1 tin 0,125lt	29 400	12,36/tin
	<b>TRÜFFELGRAU</b>	1 tin 0,125lt	50 111	12,36/tin
	<b>TAUPE</b>	1 tin 0,125lt	29 401	12,36/tin
	<b>COLOURLESS MATT DE LUXE</b>	1 tin 0,125lt	29 405	12,36/tin







## PROVITAL finish MAINTENANCE & CARE

		PACKING UNIT	ITEM NUMBER	EURO / UNIT	
	<b>ProVital Finish</b> developed for the initial and full care of high trafficked floors. Linseed oil, rosemary oils and different waxes compliment the layer of protection and guarantee the impregnation of edges  Consumption: 16 ml/m <sup>2</sup>	3 tins per box 5 lt each	29 433	35,12/lt	
		6 bottles per box 1 lt each	29 432	41,41/lt	
	<b>ProVital Maintenance Spray</b> Easy to use for maintaining ProVital finish surfaces. Consumption: 5 ml/m <sup>2</sup>	<b>01 CLEAR</b> Maintenance Spray clear, with vaporiser to be used for all ProVital finish surfaces	0,5 lt	29 408	14,73/tin
		<b>01 CLEAR</b> Refill	5 lt	29 409	97,34/tin
		<b>02 WHITE</b> Maintenance Spray, with vaporiser Polar, Edelweiss, Savanne, AshIce	0,5 lt	29 410	14,73/tin
		<b>03 GREY</b> Maintenance Spray, with vaporiser Taupe, Trüffelgrau	0,5 lt	29 412	14,73/tin
		<b>04 BROWN</b> Maintenance Spray, with vaporiser Havanna, Cognac	0,5 lt	29 414	14,73/tin
		<b>05 BLACK</b> Maintenance Spray, with vaporiser Fumed Oak	0,5 lt	29 416	14,73/tin
	<b>ProVital Clean &amp; Care</b> Simple application, for cleaning of all PVf surfaces Solvent-free and biodegradable Consumption: 30 ml/10 liter/100 m <sup>2</sup>	5 lt	29 419	13,39/lt	
		1 lt	29 418	14,73/lt	
	<b>ProVital Maintenance Set</b> Maintenance Spray with vaporiser; Pro Vital Clean & Care; cloths. Consumption: 5 ml/m <sup>2</sup>				
	<b>01 CLEAR</b> Maintenance Spray	1 Set	29 420	46,45/Set	
	<b>ProVital Cleaner - for professional use</b> High quality, highly concentrated biodegradable detergent. PVC can be used pure for selective cleaning of certain areas or mixed with water for thorough cleaning.  (about 100 m <sup>2</sup> /l/thorough cleaning)	6 bottles per box 1 lt each	29 434	16,58/lt	
	<b>Cleaning Soap No.20</b> a high-quality, concentrated combined soap, based on natural oils/resins and therefore biodegradable. Consumption: 30 ml/10 lt water/100 m <sup>2</sup>	6 bottles per box 1 lt each	13 770	14,73/lt	

## UNDERLAYS

		PACKING UNIT	ITEM NUMBER	EURO / UNIT
	<b>WP Sekura approx. 3 mm</b> natural fibre, no formaldehyde, antistatic resilient, suitable for subfloor heating systems load capacity: 25 t per m <sup>2</sup> Sound insulation: approx. 20 dB	16 rolls per pallet à 25,19 m <sup>2</sup>	20 763	4,74/m <sup>2</sup>
	<b>Cork Mat 2mm</b> natural material high pressure resistance suitable for subfloor heating systems Sound insulation: 17 dB	18 rolls per pallet à 20 m <sup>2</sup>	13 640	3,71/m <sup>2</sup>
	<b>Profi-Parkett PE 3 mm</b> Polyethylene-foil	1 roll à 25 m <sup>2</sup>	13 636	1,24/m <sup>2</sup>
	<b>WP Looseglue 3 mm</b> Acoustic underlay made from recycling material (C2C) Floating installation to the subfloor and self-adhesive to the parquet. Ideally suitable for refurbishment. For 2- and 3-layer parquet (except WP Strip, Imperial Plank and products with HDF supporting material) Footfall absorption: 23 dB Footfall absorption in connection with the parquet (14 mm structural height): 18 dB	1 roll à 15 m <sup>2</sup>	49 549	13,60/m <sup>2</sup>

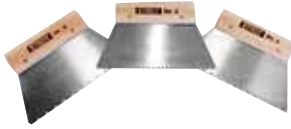
## ACCESSORIES

		PACKING UNIT	ITEM NUMBER	EURO / UNIT
	<b>Accessories</b>			
	Sanding Pad, diameter 410 mm	piece	13 145	8,65/pc.
	Superpad white, diameter 406 mm	piece	13 641	8,76/pc.
	Superpad red, diameter 406 mm	piece	13 642	8,76/pc.
	Polish-cloth	piece	13 645	1,24/pc.
	<b>Trowel</b>			
	<b>Trowel No. 4</b>	piece	13 791	6,80/pc.
	<b>Trowel No. 5</b>	piece	13 792	6,80/pc.
	<b>Trowel No. 14</b> With special tothing (three higher corrugations) to avoid cavities	piece	50 033	18,03/pc.
	<b>WP Installation Ring</b>			
	Tool for installation of fully adhered floors	piece	29 037	129,88/pc.
	<b>WP Fidbox</b>			
	Fidbox V6.0 red	piece	23 948	Price on request



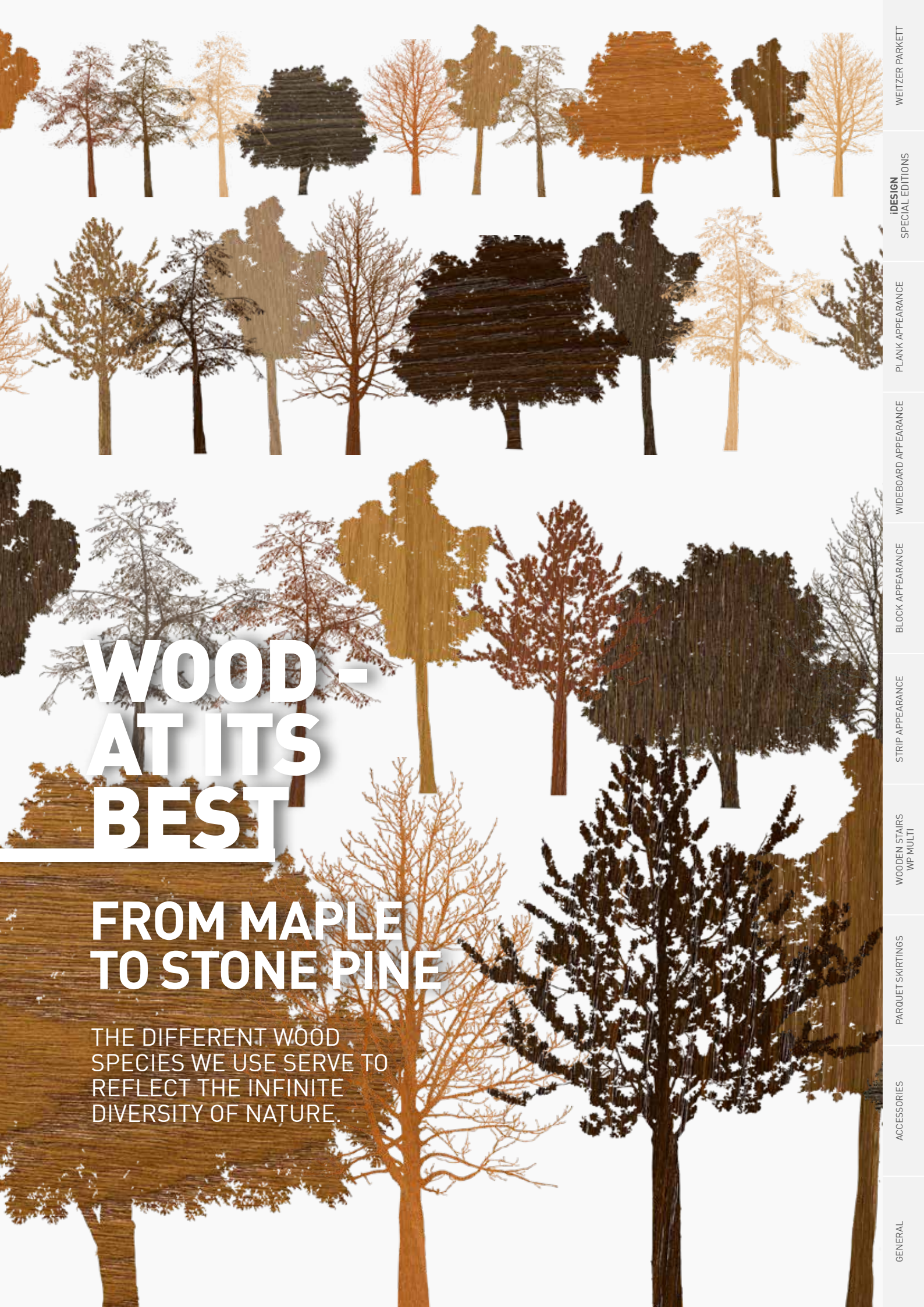

# WOOD - AT ITS BEST

## FROM MAPLE TO STONE PINE

THE DIFFERENT WOOD SPECIES WE USE SERVE TO REFLECT THE INFINITE DIVERSITY OF NATURE.

- WEITZER PARKETT
- DESIGN SPECIAL EDITIONS
- PLANK APPEARANCE
- WIDEBOARD APPEARANCE
- BLOCK APPEARANCE
- STRIP APPEARANCE
- WOODEN STAIRS WP MULT
- PARQUET SKIRTINGS
- ACCESSORIES
- GENERAL



## WOOD - AT ITS BEST

OUR WOOD SPECIES MIRROR MOTHER NATURE'S DIVERSITY.

**OAK - THE STEADFAST ONE** BOTANICAL NAME QUERCUS

The highly characteristic, long-living oak is amongst the most valuable of domestic timbers. The timeless classic stands for robustness - the wood of this dependable tree is durable, hard, firm and elastic all in one. This makes it the perfect wood for a wide range of additional colour treatments, because it works with all furniture styles and is perfect for use with underfloor heating, oak remains the wood of choice for most people selecting a parquet floor.

**Origin:** primarily Austria, Hungary and Croatia.

**BEECH - THE FLEXIBLE ONE** BOTANICAL NAME FAGUS SYLVATICA

The beech is Austria's most common deciduous tree, and is often affectionately referred to as the "mother of the forest" as a result. The hard, durable wood, with its fine, discreet growth pattern, is easy to steam bend, after which it retains its new shape. The diverse range of styles to which beech lends itself, from rustic to elegant, make it the wood most used in parquet after oak. Beech wood is distinctive for its light yellow to pinky-brown colouring.

**Origin:** Austria and Hungary .

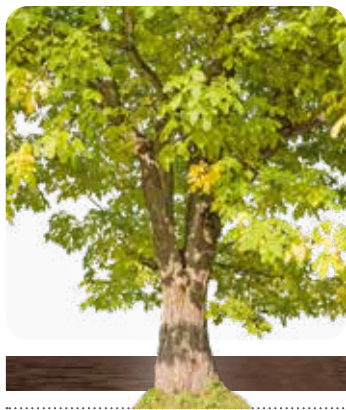
**WALNUT - THE PRECIOUS ONE** BOTANICAL NAME JUGLANS NIGRA

One of the most valuable and sought-after timbers, walnut has been viewed for centuries now as one of the most precious wood species for the production not just of parquet flooring and furniture, but also of musical instruments. Thanks to its colouring, which ranges from matt to blackish-brown, and its marking, this attractive wood gives any room it graces a particularly luxurious ambience. Its varied appearance makes it the ideal choice for those wishing to create effective contrasts.

**Origin:** Central and Eastern Europe, USA

**ACACIA- THE ROBUST ONE** BOTANICAL NAME ROBINIA PSEUDOACACIA

The wood of the perennial acacia has a wide range of different uses: it is one of the heaviest and hardest domestic wood species, and has a high level of resistance. One special characteristic of acacia wood is its resistance to weathering, while it is also highly stable and flexible. Visually, the acacia's distinct structuring and warm, reddish-brown colouring, which is brought out by means of a steam execute, is highly pleasing.

**Origin:** Hungary



# WOOD - AT ITS BEST

OUR WOOD SPECIES MIRROR MOTHER NATURE'S DIVERSITY.



## ASH - THE VITAL ONE BOTANICAL NAME FRAXINUS EXCELSIOR

Thanks to the high quality of its wood, the ash is one of the most precious deciduous woods, and together with beech and oak, one of the most important timbers in Central Europe. The expressive, distinctively structured wood, with its pronounced annual rings, is harder, tougher and more flexible than that of many other trees. For that reason, ash wood is most popular amongst those with the highest requirements when it comes to toughness and flexibility. Thanks to its special marking with a brown core, the ash is often known as the 'core ash'.

**Origin: Austria, Hungary and Croatia.**

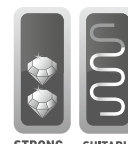

## CANADIAN MAPLE - THE CHARMING ONE BOTANICAL NAME ACER SACCHARUM

Canadian maple is both harder and more distinctive in its graining than the mountain maple. The sugar maple, as this wood is also known due to the famous maple sugar which can be produced from the sap of the tree, is one of the most valuable of the maple species. With its eyed texture and the warm appearance of its wood, the Canadian Maple is popular amongst those wishing to combine it with other woods, and has a wide range of uses compared to other light wood species due to its hardness.

**Origin: Canada and North-Eastern USA**

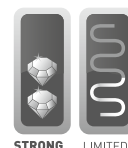

## CHERRY - THE WARMING ONE BOTANICAL NAME PRUNUS AVIUM

Cherry continues to be a classic in the furniture world, and was the most popular wood of the Biedermeier and art nouveau era. Again and again, this refined precious wood motivated designers of the time to create elegant, beautifully shaped - and of course, comfortable - furniture. Its reddish-gold brown colour gives any room a warm, comfortable radiance. The lively, natural graining makes it particularly decorative, and the perfect wood to use in contrast with white or darker woods.

**Origin: primarily Austria and Croatia.**

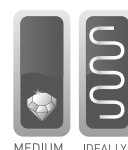

## STONE PINE - THE AROMATIC ONE BOTANICAL NAME PINUS CEMBRA

The stone pine is one of the few domestic wood species which, as well as its striking graining (numerous dark-brown knots), has an unmistakable scented aroma which hangs strongly in the air. The essential oils contained in pinewood have been proven to have a positive effect on our health and wellbeing. According to a survey by Joanneum Research Austria, pinewood reduces the heart rate and promotes regeneration in the body. Stone Pine also has a positive influence on our sensitivity to weather conditions. In addition to this, pinewood has a high antibacterial effect, and even serves as an effective protection against insects thanks to the special substances contained in it. As a result, the stone pine is primarily used in bedrooms and wellness areas.

**Origin: selected mountain regions in Austria.**

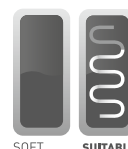



## NO SOONER SAID THAN DONE.

We listen to Mother Nature, and feel obliged to align our company with the environment. We invite you to follow our example!

- Our raw timber is almost exclusively derived from European, sustainable forests.
- We are the first parquet manufacturer to have ceased using tropical hardwood timber for a number of years.
- Support for Greenpeace forest projects. By purchasing a Weitzer Parkett product, you are contributing to saving the last remaining virgin forests in Romania.
- Energy is a valuable resource, our internal biomass power plant, photovoltaic systems and hydroelectric power plant allow us to produce not only environmentally friendly district heating, but also eco-power. The energy produced in this sustainable manner provides power not only for Weitzer Parkett but also for more than half of the city of Weiz. This corresponds to a capacity of more than 2000 households.
- We make a significant contribution to a positive eco balance by means of our overall value-add chain: resources from nearby locations, short transport paths, production in Austria, renewable energy, and much more besides.
- **We are a step ahead: Weitzer Parkett is the first and only manufacturer in the market to offer an overall solution for parquet flooring and adhesive that is free from plasticizers.**

THIS IS PARQUET INTELLIGENCE:

## HAND IN HAND WITH MOTHER NATURE

**Do you expect Environmental Responsibility that you can trust?**

**Our Intelligent Solution:** Tropical timber has been a taboo for us for a long time and we actively support Greenpeace's forest protection projects. Our innovative strength helps us to implement particularly efficient measures in matters of ecology: our in-house biomass co-generation plant, photovoltaic system, and hydroelectric plant are just a few examples of our responsible actions in terms of future generations.



# WE LISTEN TO MOTHER NATURE

OUR ECOLOGICAL  
RESPONSIBILITY  
FOR FUTURE  
GENERATIONS.



70 m<sup>2</sup> WP Charisma  
Oak planks bind  
1 ton of CO<sub>2</sub>

„Healthy flourishing forests play a key role in the global climate, and consequently for life as a whole. Accepting responsibility for the environment is a major concern for us. That’s why as personal sponsors, we support the **GREENPEACE** forest campaign in Romania for the preservation of the last remaining virgin forests in Europe“

Dr. Nicola Weitzer  
Mag. Alexandra Decker-Weitzer



## ENVIRONMENTAL RESPONSIBILITY

OUR CERTIFICATIONS PROVE OUR LIVED ENVIRONMENTAL PROTECTION AND SUSTAINABILITY

\*FSC/PEFC: product certification available upon request.

### FSC®: WE ARE CERTIFIED.



The mark of  
responsible forestry

FSC® (Forest Stewardship Council®) confers its certificates only on those companies using woods for their products that have been felled without exploiting natural, economic, or social resources.

### WE'RE TAKING RESPONSIBILITY.



Weitzer Parkett holds the PEFC Certificate of sustainable forestry. This Europe-wide system of forest certification acts as a common framework for national and regional certification schemes PEFC (Programme for the Endorsement of Forest Certification scheme) is a certification system initiated by European private forest owners and promotes sustainable forestry.

### ENVIRONMENTAL PROTECTION: WE'RE TAKING A STANCE.



As the world's oldest and best-known eco-label, the Blue Angel stands for credibility and competence. It identifies products which are particularly environmentally friendly and at the same time meet high demands in relation to health and employment protection. Weitzer Parkett products have been tested in accordance with these strict guidelines, and as a result are entitled to carry the Blue Angel seal of approval.

### WE STAND FOR REAL VALUES.



www.realwood.eu

Developed by the European Federation of the Parquet Industry ("FEP"), only solid and multi-layered real wood floors such as those manufactured by Weitzer Parkett may carry the Real Wood logo. The campaign for real wood floors has been developed to avoid confusion between real timber floors and laminate floors (laminate cannot carry the "Real Wood" label).

### YOUR TRUST IS IMPORTANT TO US.



The GREENGUARD certificate guarantees no harmful chemical emissions of our 3-layer floors.

### WE LET YOU BREATH EASILY.



The TÜV PROFiCERT product Interior is an independent quality symbol for interior products with regard to emissions. Under this voluntary, external monitoring scheme, the emissions of our products are tested and assessed according to the most stringent criteria. In this way we verify that: Weitzer Parkett ensures a good interior air quality in your rooms.

# GENERAL TERMS AND CONDITIONS OF BUSINESS

## SCOPE

The principles of these General Terms and Conditions of Business (referred to below as 'AGB') are conceived for legal transactions between Contractors as defined in § 1 of the UGB (Austrian Commercial Code). If, by way of exception, they are to be applied to legal transactions with consumers as defined in § 1 of the KSchG (Consumer Protection Act), they shall only apply to the extent that they do not contradict the provisions of this Act. These AGB shall apply unless the Contracting Parties have explicitly agreed otherwise in writing. Conditions of the Buyer to the contrary of or deviating from these AGB are not recognized. These AGB of the Vendor shall also apply if the Vendor renders the delivery to the Buyer without reservation in the knowledge of contradictory conditions of the Buyer or conditions deviating from these Conditions of Delivery. Agreements made verbally or on the telephone by field or office staff shall require written confirmation from management in order to be effective. The subsequent regulations concerning the delivery of goods shall also apply analogously for other services provided by the Vendor. These AGB shall also be valid for future transactions with the Buyer.

## QUOTATION

Quotations of the Vendor are provisional and without obligation. If the buyer does not immediately object to the conditions contained therein upon receipt of the sales confirmation, then a buyer's order becomes legally effective as soon as the seller transmits the sales confirmation via email or fax. Beginning at an order quantity of 100 m<sup>2</sup>, the order from the buyer has to be accomplished in writing via email or fax together with transmission of the construction schedule. The Vendor is entitled to accept an order within 4 weeks by sending an order confirmation.

If the order confirmation of the Vendor contains changes compared to the verbal or written order, these changes shall apply as recognized by the Buyer if it does not object to them within 24 hours.

The buyer must secure the seller's agreement if the former wishes to withdraw from the contract after the sales confirmation has become binding. Moreover, the buyer has to pay a cancellation fee in the amount of €100.00 on a net merchandise value of up to €1,000.00 and a cancellation fee of 10% of the contract value on a greater net merchandise value. The cancellation fee is calculated separately. The seller is not entitled to a cash discount deduction when the cancellation fee is paid. Custom-made products cannot be cancelled in principle.

## PRICING - CONDITIONS OF PAYMENT

Unless specified otherwise in the order confirmation, prices shall apply ex works of the Vendor, duty unpaid, without packaging and without shipping. These are invoiced separately. As of an agreed net value of the goods, the deliveries shall be understood as being free to the address of the Buyer, but excluding any unloading or carrying. Express deliveries by rail and parcel service deliveries shall always be at the expense of the Buyer. Orders with a net order value of less than EUR 150.00 (excl. VAT) shall be furnished with a minor invoices surcharge of EUR 5.00. All prices are referred to at the time of the order confirmation and only apply, unless a separate written agreement is in place, to the quantities contained in the order confirmation. The Vendor reserves the right to increase the prices by a reasonable extent if costs increase after conclusion of the Contract, particularly due to the collective agreements or increases in the prices of materials. In the event that the Contract is concluded without a price being set, the sales price valid on the day of the delivery shall be invoiced. The statutory value added tax is not included in the price. This shall be indicated separately in the invoice at the legal rate on the day of invoicing. The Vendor is also entitled to transmit invoices to the Buyer in electronic form. The Buyer explicitly declares that it agrees to the transmission of invoices in electronic form by the Vendor. Unless specified otherwise in the order confirmation, invoices shall become due for payment without deduction at the time of delivery, but at the time of invoicing from the invoice date at the latest. In the case of special designs, the good is to be paid for in advance, and the Vendor is then only obligated to begin production when the purchase price has been received in full. If non-payment is not made after 8 days have passed since the order confirmation, the Vendor is no longer bound by the order. The Vendor is entitled to demand advance payments or a guarantee of the payment if doubts exist as to the willingness or ability of the Buyer to make the payment. Payments by bill or cheque are not accepted by the Vendor. If a plurality of accounts receivable exists, then the payments of the Buyer shall each be credited to the oldest account receivable. If outstanding debts have been transferred for pursuit externally (by a debt collection agency or lawyer), then any payments received shall firstly be used to cover any possible ancillary costs associated with the pursuit of the debt (default interest, dunning, debt collection and other charges). Remaining amounts shall be credited to the oldest accounts receivable for deliveries and services. The Buyer shall only be entitled to discounts if these have been explicitly agreed in writing. If there are any discountable invoices on the basis of a separate agreement, deductions for discounts shall only be accepted if payment is made within the set period, if the deductions conform to the agreement, and the Vendor has no other outstanding accounts receivable from the Buyer. The Buyer shall not be entitled to withhold payments due to warranty claims or other counter-claims not recognized by the Vendor. If the Buyer defaults on an agreed payment or other performance, the Vendor shall be entitled to insist upon fulfillment of the Contract, and to postpone performance of its own obligations until the outstanding payments have been made or other performance has been made, apply a reasonable extension of the date for delivery, demand payment in full of the outstanding purchase price, as of the due date, demand default interest in the amount of 8% above the primary rate of the Austrian banks, and demand reimbursement of all costs incurred in obtaining performance (payment) from the Buyer, in particular the costs of a debt collection agency or lawyer's fees, or, after granting a reasonable additional period, withdraw from the Contract.

If the Vendor demands payment in full of the outstanding purchase price due to default of payment, and if the Buyer nevertheless fails to make payment of this debt or render other performance, then the Vendor shall be entitled to withdraw from the Contract by giving written notification. In this event, the Buyer shall be obliged, at the Vendor's request, to return to the Vendor any goods that have already been delivered and to reimburse to him the incurred depreciation in value of the goods, and reimburse to him all expenses incurred by the Vendor

in executing the Contract. In addition to this, the Vendor shall charge a handling fee of 10% of the net order value. In the event that no goods have been delivered, the Vendor shall be entitled to provide the finished or partially finished parts to the Buyer and demand payment of the appropriate proportion of the purchase price for doing so.

## RETENTION OF TITLE

The Vendor shall retain title to the object of purchase until the Buyer has completely fulfilled all of his obligations, including any interest, expenses and costs.

In the event that the object of purchase is seized or otherwise attached, the Buyer shall be expected to assert the Vendor's title and to notify the Vendor immediately in writing. The Buyer shall be entitled to resell the object of purchase in the due course of business. In the event that the goods are resold, however, the Buyer shall be obliged to retain title to the purchase goods until payment in full has been made. At this point, the Buyer shall assign to the Vendor the amount receivable from his customer up to the amount of the still outstanding purchase price. The Buyer undertakes, on the one hand, to notify his customers immediately in writing of this assignment upon conclusion of the resale and, on the other hand, to notify the Vendor of the name and address of the customer and of the amount of his account receivable from the customer. The Vendor shall be entitled to avail himself of the assignment at any time and to collect the debt himself. The Buyer undertakes to treat the object of purchase carefully and to insure it sufficiently at replacement value at his own expense against damage caused by fire, water and theft. Executing or transformation of the purchase object by the Buyer shall always be performed for the Vendor. If the purchase object is executed together with other objects that do not belong to the Vendor, the Vendor shall acquire co-ownership of the new object in proportion of the value of the purchase object to the other executed objects at the time of executing. The same shall apply to the object created by executing as applies to the objects of purchase delivered with reservation of title. We explicitly state that executed goods also remain our property until they have been paid for.

## DELIVERY

Unless otherwise agreed, the periods for delivery shall apply ex works, be non-binding, and begin on the latest of the following dates: date of order confirmation; date of fulfilling all of the technical, commercial and financial conditions incumbent on the Buyer; date at which the Vendor receives a down payment to be paid before delivery of the goods or a letter of credit is opened.

If there is no fixed delivery date for a binding order, then the seller has the right to draw on the currently warehoused merchandise for contracts with fixed delivery dates.

Shipping takes place at the risk and the cost of the Buyer. The Vendor reserves the right to choose the nature and route of the shipping, excluding any liability. The Vendor is entitled to make part-deliveries as long as nothing to the contrary is explicitly agreed. The Buyer is obliged to accept part-deliveries and to pay within the framework of the agreed payment conditions. The Buyer must check the delivery immediately upon handover, although within 3 working days at the latest. The Buyer loses the right to invoke a failure of the delivery to comply with the Contract if it neglects to inspect the delivery or if it does not point out the failure to conform in writing, defining the details precisely, immediately after the time at which it could have recognized the failure by means of an ordinary inspection. Externally recognizable transport damage is to be pointed out immediately upon receipt, and the Vendor notified of the nature and extent of this damage immediately in writing. On site, the Buyer is obligated to Notes down the details of the nature and extent of the transport damage on the freight document or delivery Notes.

If shipment is delayed at the buyer's request, then he will be billed for the costs of storage accrued during storage in the amount of €0.90/m<sup>2</sup>/month (with full pallets) or €1.90/m<sup>2</sup>/month (with partial pallets) starting four weeks after notification of readiness to deliver. The storage fee is calculated separately. The seller is not entitled to a cash discount deduction when the storage fee is paid.

After the setting and fruitless expiry of a four-week period, the seller is also entitled to otherwise access the delivery item and to deliver to the buyer with an appropriately extended period. The seller is furthermore also entitled to withdraw from the contract after the setting and fruitless expiry of a reasonable period, especially when

- there is doubt concerning the customer's creditworthiness,
- the customer does not make the prepayment necessary for the contract to be sent,
- the customer has already failed to pay at least two months' worth of the calculated storage costs, or
- Postponement of the shipment exceeds the validity of the respective calendar year's price list.

If the buyer agrees to a price adjustment in terms of the new price list, then the seller has the right to refrain from withdrawing from the contract.

In the event of later amendments to the Contract which could influence the time of delivery, the time of delivery is to be extended reasonably, unless this impacts special agreements relating to this time of delivery. If delivery is delayed due to the occurrence of unforeseen, extraordinary circumstances (interruption of operations, official action, war, blockade, riot, delay in delivery of essential raw and construction material, energy supply difficulties or force majeure, for example), regardless of whether these have occurred at the Vendor or a supplier, the delivery period shall be extended, if delivery or performance does not become impossible, by a reasonable period. If delivery or performance is rendered impossible by the aforementioned circumstances, the Vendor shall be released from the obligation to deliver. These provisions shall also apply in the event of strike or lockout. If, in this event, the delivery period is extended or the Vendor is released from the obligation to deliver, the buyer shall not be entitled to derive any claims for damages herefrom. If the obstruction persists longer than three months, the Buyer shall be entitled, after granting a reasonable additional period, to withdraw from the as yet unfulfilled part of the Contract. If the Vendor is guilty of a delay in delivery, the Buyer shall be entitled to demand performance or, after granting a reasonable additional period for delivery, to declare



# GENERAL TERMS AND CONDITIONS OF BUSINESS

that it is withdrawing from the Contract. If the additional period granted by the Buyer is not observed due to the fault of the Vendor, the Buyer shall be entitled to withdraw from the Contract with regard to all as yet undelivered goods and all delivered goods that cannot be used appropriately alone and without the undelivered goods by giving written notification. In this event, the Buyer shall be entitled to reimbursement of payments made for the undelivered goods or for the unusable goods and, if the delay in delivery is due to gross negligence on the part of the Vendor, to reimbursement of justified expenses which it had to make until the annulment of the Contract and for the execution thereof. The Buyer shall be obliged to return any delivered and unusable goods to the Vendor. Other claims of the Buyer vis-à-vis the Vendor due to the Vendor's delay in delivery, particularly claims for damages due to non-performance, shall be explicitly excluded. If the Buyer fails to accept the goods delivered under the Contract at the place and time agreed in the Contract, the Vendor shall be entitled to demand performance or, after granting a period for acceptance, to withdraw from the contract. In this event, the Vendor shall be entitled to demand the damages incurred by it, including any additional expenses, from the Buyer. In this event, the risk of accidental perishing or accidental deterioration of the purchase goods shall pass to the Buyer at the date at which the Buyer fails to accept delivery. The Vendor shall be entitled to make partial and advance deliveries. We draw attention to the fact that our deliveries take place in compliance with the terms of business of our company exclusively; no regulations to the contrary whatsoever can be accepted. Should you not agree with this procedure, you have the option to cancel your order within 3 days after the purchase order date. After this time limit has expired, the order becomes binding.

## RETURNS

Returns shall only be accepted within eight weeks as of the date of invoice. No returns shall be accepted after this date! Sales promotion products, special products and custom-made products may not generally be returned. Only faultless goods in undamaged original packaging shall be accepted as returns. Up to a net invoice value of goods of EUR 500.00, a EUR 50.00 handling charge shall be invoiced; beyond this, the handling charge shall be 10%. The sender shall always bear the shipping costs of return delivery.

## WARRANTY AND LIABILITY

In accordance with the following provisions, the Vendor shall give warranty for any faults impairing merchantability that are due to a fault in design, material or workmanship. Deviations in measurement and quality are admissible within the framework of the norms agreed or those in place in the country of the Vendor. No warranty is given for production- or materials-related deviations in colour nuances or grading of the good. This also applies to models of the good which are described as lower quality, such as "Secunda", for example, when warranty is also excluded. The warranty obligation shall only exist for such faults that occur during a period of twenty-four months (warranty period) as of the date of passing of risk or, in the case of delivery with installation, as of the completion of assembly. The Buyer undertakes to notify any apparent faults detected at acceptance immediately in writing, describing the nature and extent of these faults in detail, and to have such faults confirmed by the deliverer. The invoice for the reclaimed delivery is to be presented to the Vendor. The following periods for complaints shall apply in the event of undamaged packaging but damaged contents: postal and parcel services, twenty-four hours as of acceptance; shipping companies and rail, seven days as of acceptance. In these cases, too, faults must be notified in writing, giving details of the nature and extent of the faults, and the invoice for the reclaimed delivery is to be presented. If the above periods for notification are not observed, the shipping company shall not be liable for damages. In the event of a complaint, the Buyer shall also be obliged to first accept the goods and to unload and store the goods with due care and at his own risk and cost. If the faults are to be remedied by the Vendor, the Vendor shall be obliged, at his option, to either remedy the faulty goods on site, have the faulty goods or the faulty parts returned for rectification, or replace the faulty parts. Rectification of faults shall not extend the warranty period. If the Vendor has the faulty goods or parts returned for rectification or replacement, the Buyer shall assume the costs and risk of shipment, unless otherwise agreed in writing. Return of the rectified or replaced goods or parts to the Buyer shall be at the Vendor's cost and risk, unless otherwise agreed. The faulty goods or parts replaced in accordance with this section shall be available to the Vendor. The Vendor shall only assume the costs of rectification of faults performed by the Buyer himself if he has given his consent hereto in writing. The Vendor shall only give warranty for such faults that occur under the agreed operating conditions and in the normal course of use. It shall not give warranty for any faults that occur due to incorrect set-up by the Buyer or its authorized representative, incorrect maintenance, incorrect repairs or repairs performed without the Vendor's written consent, or changes made by third parties, or due to normal wear and tear. The Vendor shall only give warranty for parts of the goods that he has purchased from third parties to the extent of the warranty claims due to him vis-à-vis the sub-contractor. If the Vendor manufactures goods on the basis of the Buyer's construction specifications, drawings or models, the Vendor's liability shall not include the correctness of the design, but rather the fact that execution of the goods was performed to the Buyer's specifications. In such cases, the Buyer undertakes to indemnify the Vendor against any violation of industrial property rights. The Vendor shall not give warranty for the acceptance of repair jobs in the event of modifications or conversions of all goods, including third-party goods, or in the event of delivery of used goods. Unless otherwise deriving from these provisions, all further claims by the Buyer, on whatever legal grounds, shall be excluded. The Vendor shall hence not be liable for any damage that is not incurred on the delivered goods themselves, also, particularly, not for loss of profit or other pecuniary loss of the Buyer. In any case, all warranty claims shall be limited to the purchase price to be paid by the Buyer. As of commencement of warranty, the Vendor shall assume no liability exceeding the liability specified in this section. He shall also not be liable for any faults originating before the date of the passing of risk. The object of purchase shall only offer the safety that may be expected on the basis of approval regulations, operating instructions, Vendor instructions concerning handling of the object of purchase, particularly with regard to any prescribed inspections and other instructions provided.

## OTHER CLAIMS FOR DAMAGES

Unless otherwise deriving from the aforesaid, all claims for damages vis-à-vis the Vendor shall be excluded without regard for the legal nature of the claim asserted. This exclusion shall hence apply in particular to all claims for damages for injuries to persons, damage to property that is not the object of the Contract, other damage or loss of profit, unless the circumstances of the individual case prove gross negligence on the part of the Vendor. Liability for damages resulting from the Product Liability Act and product liability claims that may be derived from other provisions shall be explicitly excluded.

## INTELLECTUAL PROPERTY

Plans, drawings and other documents of a similar nature, as well as brochures, catalogues, patterns and the same remain the intellectual property of the Vendor. Any utilization or duplication shall require the explicit written consent of the Vendor. In the event of their utilization without consent, the Vendor is entitled to assert a compensation fee equal to 25 % of the estimated sum.

## PLACE OF JURISDICTION, APPLICABLE LAW, PLACE OF PERFORMANCE

The venue for all disputes arising out of or in connection with this Contract is Graz. The place of delivery and payment shall be the Vendor's registered office, also if delivery takes place, as agreed, at a different place. The contractual relationship is subject to Austrian law, with the exception of the UNCITRAL uniform law on sale of goods [Convention on Contracts for the International Sale of Goods of 11.04.1980], whose validity is explicitly excluded.

## DATA PROTECTION

The Buyer hereby gives its consent to its data being stored and executed by the Vendor in electronic form. Furthermore, the Buyer declares that it consents to an enquiry being made to the Trade Credit Database ("Warenkreditvidenz der Creditreform") or another appropriate information office. The Buyer also consents, in the event of a delay in its payment, to all its data at the Warenkreditvidenz being transmitted and made available to third parties by the Warenkreditvidenz.

## GENERAL

If a provision of these AGB is declared void or legally ineffective, the remaining provisions shall remain unaffected by this, and are to be interpreted as if the Contract had been concluded without the invalid provision.

The same applies to loopholes in the Contract. Any controversies relating to fulfillment of this Contract do not entitle the Buyer to suspend or delay due payments. The Buyer may only assign its rights arising out of the Contract after gaining the written consent of the Vendor.

## CORRECT AS AT: January 2020

All previous AGB hereby cease to be valid.







Weitzer Parkett GmbH & CoKG  
Klammstrasse 24  
8160 Weiz, AUSTRIA  
Tel.+43 (0)3172/2372-0  
Fax +43 (0)3172/2372-401  
office@weitzer-parkett.com

